

High-Speed Linear Servo Valves

OBE (On-Board Electronic) Type Linear Servo Valves

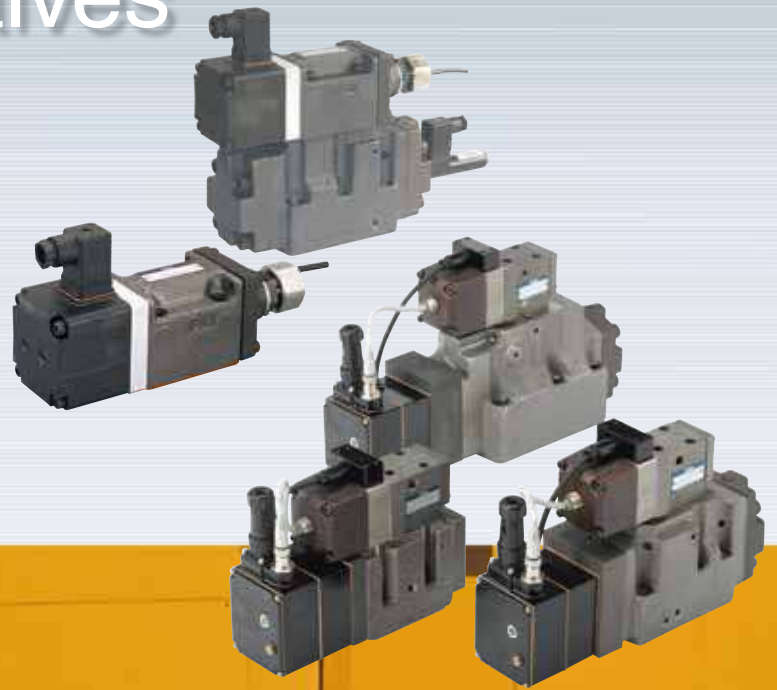

0 5 10 15 20 25

Hydraulic Fluids

Type of Fluids

Any type of hydraulic fluid listed in the table below can be used.

Petroleum Base Oils	Use fluids equivalent to ISO VG32 or VG46.
Synthetic Fluids	Use phosphate ester or polyol ester type. When phosphate ester type fluid is used, prefix "F-" to the model number because a special seal (fluororubber) will be used.
Water Containing Fluids	Use water-glycol fluids. Water-glycol fluids cannot be used for valves "without Y port" (wet type: LSVG-*EH-* <u>W</u>) or "without DR port" (wet type pilot valve: LSVHG-*EH-* <u>W</u>).

Note: For use with hydraulic fluids other than those listed above, please consult your Yuken representatives in advance.

Recommended Viscosity and Temperature

Use hydraulic fluids which satisfy both recommended viscosity and oil temperatures given in the table below.

Viscosity	Temperature
15 - 400 mm ² /s	-15 - +60 °C

Control of Contamination

Keep the hydraulic fluid clean and provide a line filter so that contamination of the fluid will not obstruct proper valve operation. To assure long life of linear servo valves, it is recommended to improve fluid cleanliness before use.

Contamination Level	Line Filter
NAS1638 Class 10 ISO4406 21/19/15	Absolute 20 μm

Instructions

Mounting

Mount the valve with the angle of the axis line L-L' within about ±15° from the horizontal plane, as shown below. The valve must be mounted in such a way that the spool axis direction is not matched with the main vibration direction; otherwise, an external force may cause the spool to malfunction.

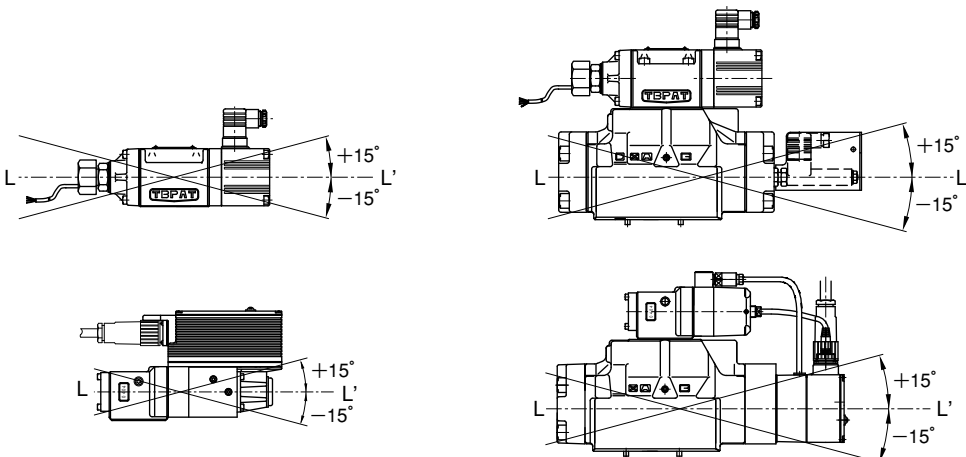

Installation Requirements

Avoid installing the valve in a strong magnetic field. Especially, the position sensor for detecting the spool position is affected by the magnetic field. Keep the valve away from devices that generate magnetic fields, such as solenoid operated directional valves. At the same time, a magnetic field generated by the valve may affect other devices; any device vulnerable to magnetic fields must not be installed near the valve.

Drain Piping (LSVG: Y Port/LSVHG: DR Port)

LSVG/LSVHG series high speed linear servo valves have a diaphragm mechanism that keeps the inside of the linear motor dry in order to meet the requirements below.

- 1) Keeping response characteristics almost unchanged when fluid viscosity varies (the response characteristics of existing proportional/servo valves vary with changes in fluid viscosity).
- 2) Protecting moving coils from iron powder or moisture in hydraulic fluids.

A special drain port is provided to define the upper limit of pressure for the diaphragm, if any, so that the valve performance is maintained. For valve installation, provide a drain line by taking into account the following piping considerations.

- ① Back pressure at the drain port should be 0.05 MPa or less and not be a negative pressure.
 - ② The drain line should be open to the air (the line end must not contact the fluid).
- ★ There are two types of pilot valves available: a dry type good in response characteristics and a wet type that eliminates the Y or DR port to improve usability.

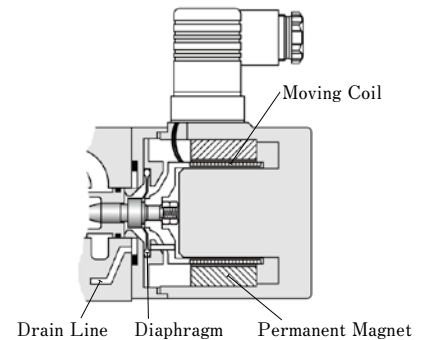

Structure of the Linear Motor

Cable Length for I/O Signals

- 1) High speed linear servo valves (amplifier-separated type)
Use a cable of up to 30 m in length.
Consult us for customized products (Model: LSVG-03/LSVHG-04, 06) that allow the use of a cable of up to 200 m in length.
- 2) OBE (on-board electronics) type linear servo valves
The maximum cable length depends on the I/O signal type. See the table below.

I/O Signal Type	Valve Model Number	Max. Cable Length
±10 V	LSV (H) G- * * EH- * * - * - * - A * / D * - 10	50 m★
4 - 20 mA	LSV (H) G- * * EH- * * - * - * - B * / E * - 10	300 m
±10 mA	LSV (H) G- * * EH- * * - * - * - C * / F * - 10	

★ Consult us when the cable length exceeds 50 m.

For both valve types in 1) and 2), pay attention to ensure that the power cable resistance is within 1 Ω and is as low as possible.

Electrical Failure and Safety Measures for Startup

Provide a separate safety circuit (e.g. uninterruptible power supply), if required, to securely continue/stop the operation of the hydraulic actuator for safety in case of electrical failure (power failure, cable disconnection, etc.) or upon startup.

Supply Pressure

The servo valves are designed to operate at constant supply pressure; variations in supply pressure should be avoided as much as possible. Especially, for systems requiring high accuracy, the circuit must be designed to keep the supply pressure constant. Ideally, an accumulator will be installed in the supply pressure line near the servo valve to avoid supply pressure fluctuations during pressure transients.

Pressure at the Return Port

The return port of the servo valve may be subject to a considerably high pressure depending on the circuit type. However, it should be used at atmospheric pressure or similar pressure as much as possible. The pressure at the return port should be equal to or below actual supply pressure.

Disassembly/Reassembly

Linear servo valves consist of high precision components. You are prohibited from disassembling or reassembling the valves; otherwise, the designed valve performance may be degraded.

Valve Pressure Difference/Load Pressure Difference

This catalog uses two terms related to pressure differences: “valve pressure difference” (used for the range of flow control and no-load flow characteristics) and “load pressure difference” (used for load flow characteristics). The terms are described below.

Valve Pressure Difference

Suppose that, in the circuit shown on the right, the fluid flows from P to A and from B to T. In this case, the sum of the pressure differences between P and A and between B and T is the pressure difference of this valve. For this four-way valve, the valve pressure difference “ ΔP ” is:

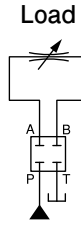

$$\text{Valve Pressure Difference} = [(\text{Pres. at P}) - (\text{Pres. at A})] + [(\text{Pres. at B}) - (\text{Pres. at T})].$$

In relation to the flow rate, an increase in the flow through the valve with a constant valve opening leads to an increase in the valve pressure difference due to increased flow resistance at the control part.

Load Pressure Difference

In the circuit above, the absolute pressure difference between A and B is the load pressure difference.

$$\text{Load Pressure Difference} = |(\text{Pres. at A}) - (\text{Pres. at B})|$$

If the resistance of piping, etc. is ignored, the difference between the supply pressure and the load pressure difference is the valve pressure difference of the linear servo valve. Therefore, a smaller load pressure difference means a larger valve pressure difference, allowing increasing the flow rate through the valve.

Flow Rate

In this catalog, the rated flow tolerance is $\pm 10\%$

The flow rate depends on the viscosity and specific gravity of each hydraulic fluid.

- Multiply each viscosity by the corresponding coefficient in the table below.

Viscosity mm ² /s	15	20	30	40	50	60	70	80	90	100
Coefficient	1.19	1.11	1.00	0.93	0.88	0.84	0.81	0.78	0.76	0.74

- Use the following formula to obtain the flow rate corresponding to a specific gravity. $Q' = Q\sqrt{(0.85/G')}$
- Use the following formula to obtain the relationship between the flow rate and the pressure for a servo valve.

$$Q_x = Q_{\text{rate}} \sqrt{\frac{\Delta P_x}{7}}$$

where Q_x : Flow rate to be determined;
 Q_{rate} : Rated flow rate (at $\Delta P = 7$ MPa); and
 ΔP_x : Valve pressure difference in the actual circuit.

Direct type High-Speed Linear Servo Valves

Direct type high speed linear servo valves use a compact and powerful linear motor as an actuator and have an extremely simple structure that connects the linear motor moving coil, the spool, and the position sensor in series.

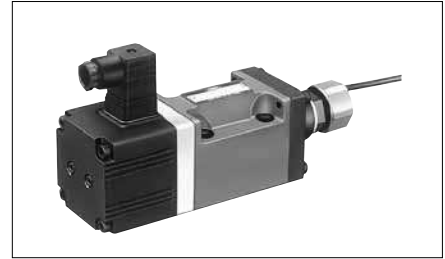

- High accuracy

These valves have a low hysteresis of 0.1 % or less, achieving high accuracy. They allow the main unit to operate with much higher repeatability.

- High response characteristics

The valves provide significantly high levels of step and frequency responses, which are typically used as measures of response characteristics; the step response is 2 ms (0 <=> 100 %)★, and the frequency response is 450 Hz/-90° (±25 % amplitude)★. Thus, the valves ensure that the main unit can achieve unprecedented high response.

(★: Representative values)

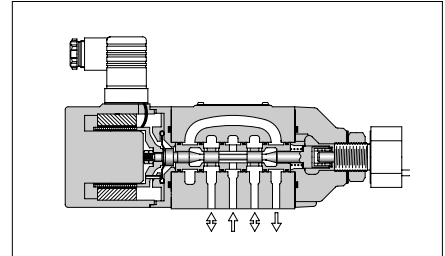

- Excellent vibration-proof characteristics

With a simple structure, the valves offer high vibration resistance.

- Excellent contamination resistance

The valves are also featured by excellent contamination resistance since they have a simple structure that directly connects the linear motor moving coil, the spool, and the position sensor. Compared to conventional servo valves for which the permissible contamination level is up to NAS 1638 class 7, the direct type linear servo valves can accept a contamination level of up to NAS 1638 class 10. These valves can contribute to greatly reducing the cost of fluid management.

Graphic Symbols

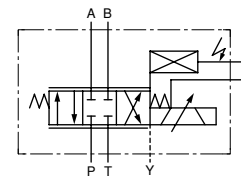

Model Number Designation

F—	LSVG	—03	—40	—R	—10
Fluid Type	Series Number	Valve Size	Rated Flow @ ΔP = 7 MPa	Cable Departure Direction	Design Number
F : Special Seals for Phosphate Ester Type Fluid (Omit if not required)	LSVG : Direct Type High Speed Linear Servo Valves	03	4 : 4 L/min 10 : 10 L/min 20 : 20 L/min 40 : 40 L/min 60 : 60 L/min	(Viewed from the linear motor side) None : Upper (Standard) R : Right L : Left	10

Exclusive Amplifiers

To ensure stable performance, it is recommended to use Yuken's AMLS series linear servo amplifiers.

Valve Model Number	Amplifier Model
LSVG-03-4/10/20/40	AMLS-A-D*-* -10
LSVG-03-60	AMLS-B-D*-* -10

Attachment

Mounting Bolt	Bolt Tightening Torque
Hex. Soc. Head Cap Screw: M8×65L···4 Pieces	30.8 - 37.7 Nm

Specifications

The specifications below are for use with a 48 V DC type exclusive amplifier; for use with a 24 V DC type amplifier, see the values in parentheses ().

Description		Model Numbers	
		LSVG-03-4/10/20/40	LSVG-03-60
Rated Flow @ $\Delta P = 7 \text{ MPa}$ ⁽¹⁾	L/min	4, 10, 20, 40	60
Max. Operating Pressure	MPa	35	
Proof Pres. at Return Port	MPa	35	
Drain Port (Y Port) Permissible Back Pres. ⁽²⁾	MPa	0.05	
Internal Leakage (PS = 14 MPa) (Viscosity: 32 mm ² /s)	L/min	1.7 or less	
Hysteresis	%	0.1 or less	
Step Response (0 \leftrightarrow 100 %, Typical) ⁽³⁾	ms	2 (3)	3 (4)
Frequency Response (± 25 % Amplitude, Typical) ⁽³⁾	Gain: -3 dB	Hz	350 (300)
	Phase: -90°	Hz	450 (370)
Vibration Proof ⁽⁴⁾		Frequency: 10 - 60 Hz, Amplitude: 4 mm, Acceleration: 7.8 - 282 m/s ² Frequency: 61 - 2000 Hz, Amplitude: 4 - 0.0038 mm, Acceleration: 294 m/s ²	
Protection		IP 64	
Ambient Temperature	°C	-15 - +60	
Spool Type		Neutral/Zero Lap	
Spool Stroke to Stops	mm	± 0.5	± 0.75
Polarity		See the description about I/O signal characteristics on page 18.	
Linear Motor Specification	Current	A	2 [Max. 6]
	Coil Resistance	Ω	4.5 [at 20 °C]
Mass	kg	5	

Note: ⁽¹⁾ Use the valves so that the relationship between the valve pressure difference and the flow rate, as specified below in "Range of Flow Control", is met.

⁽²⁾ Back pressure at the drain port (Y) should be 0.05 MPa or less and not be a negative pressure.

⁽³⁾ This value is measured for each valve; it may vary depending on the actual circuit.

⁽⁴⁾ There are restrictions on the mounting position; refer to the instructions for details.

Range of Flow Control

Control Method: 4-Way Valve

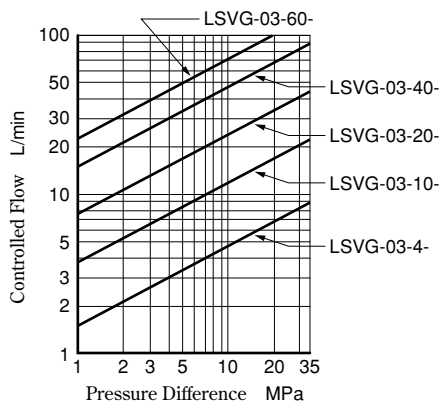
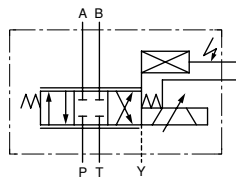

Control Method: 3-Way Valve

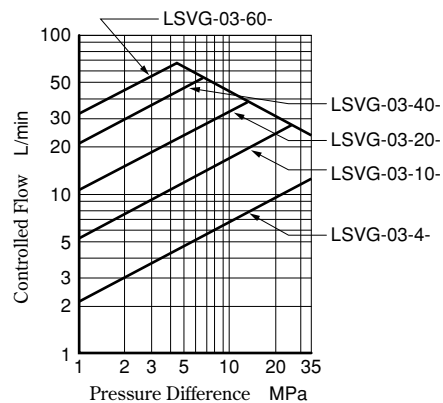
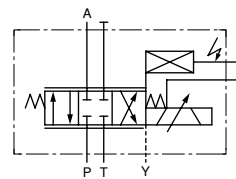

LSVG-03

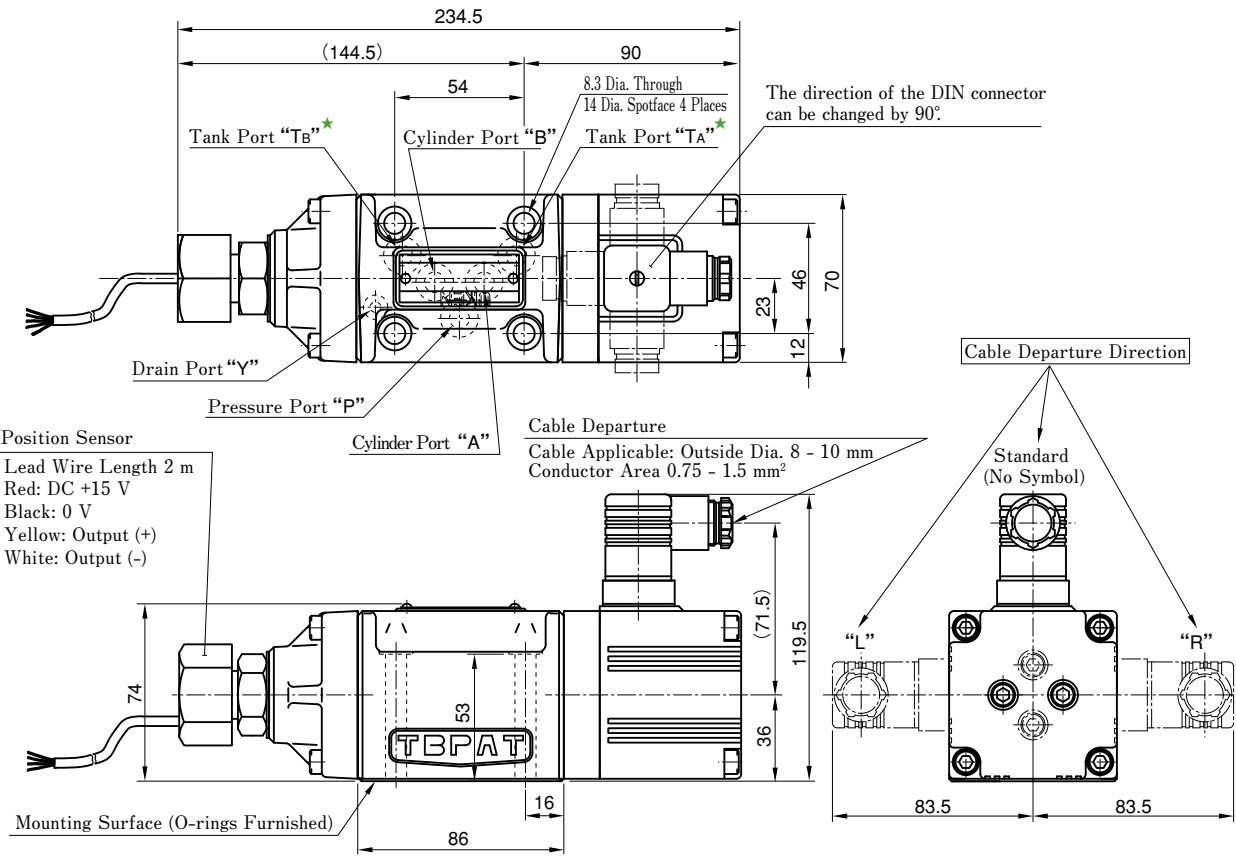

Note) Refer to the wiring diagram on page 20 for detailed connection between the DIN connector/position sensor and the amplifier.

● O-rings for the Ports

Port	O-ring Size	Qty.
P, A, B, T	AS568-014 (NBR,Hs90)	5
Y	JIS B2401-1B-P7	1

O-rings made of fluorinated rubber are required to use phosphate ester type fluids.

【Mounting Surface】

Prepare a mounting surface shown on the right. Basically, the dimensions of the mounting surface conform to the ISO standard, but the specifications for valve mounting screws are different as follows.

Consult us for valves available with M6 mounting screws.

	ISO 4401-05-04-0-94	Mounting Surface for LSVG-03
Valve Mounting Screw	M6	M8

The mounting surface should have a good machined finish.

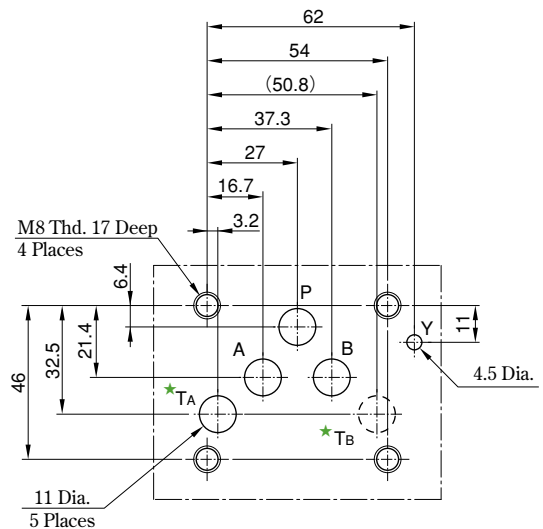

★ There are two tank ports "TA" and "TB"; however, "TA" may be used alone.

Characteristics of LSVG-03-4/10/20/40/60 (Fluid Viscosity: 30 mm²/s)

No-Load Flow Characteristics

<Conditions>

● Valve Pressure Difference : 7 MPa

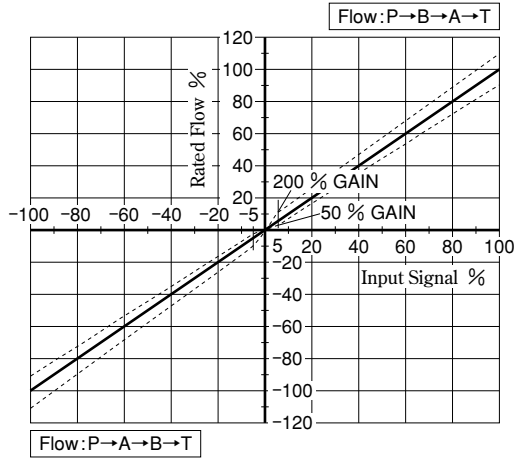

Load Flow Characteristics

<Conditions>

● Input Signal : 100 %

Note) Tolerance for Load Flow : ±10 %

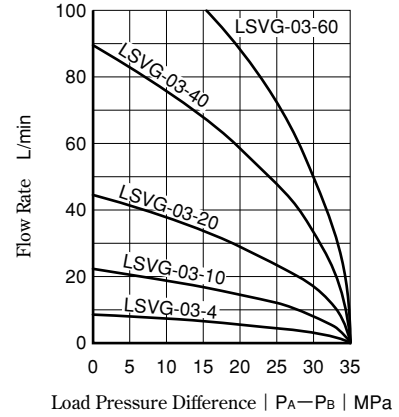

Step Response

<Conditions>

● Input Amplitude : 0 ⇔ 100 % ● Supply Pressure : 14 MPa

● LSVG-03-4/10/20/40-10

Amplifier : AMLS-A-D48- * -10 (Power Supply: 48 V DC)

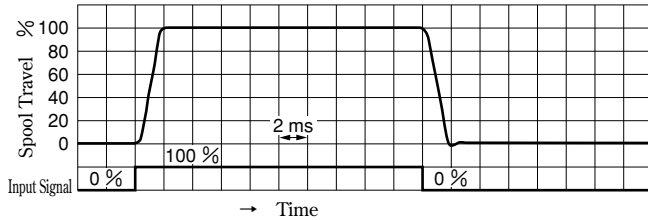

● LSVG-03-60-10

Amplifier : AMLS-B-D48- * -10 (Power Supply: 48 V DC)

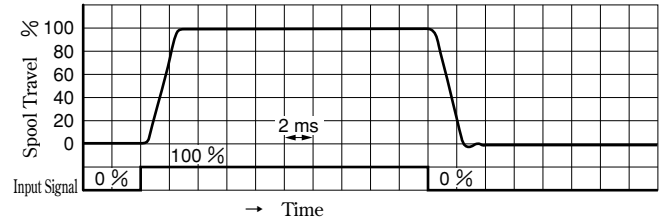

Amplifier : AMLS-A-D24- * -10 (Power Supply: 24 V DC)

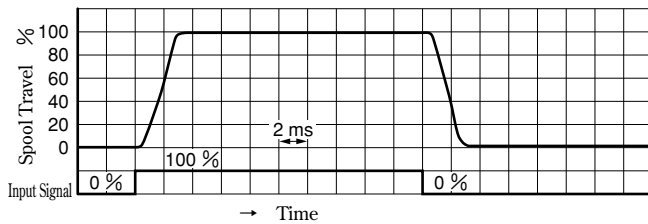

Amplifier : AMLS-B-D24- * -10 (Power Supply: 24 V DC)

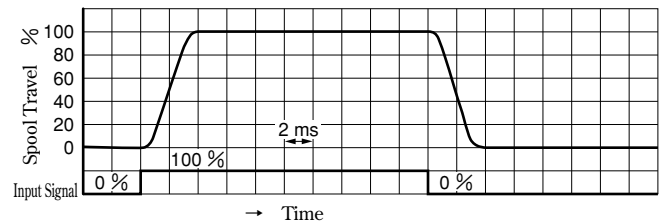

Frequency Response

<Conditions>

● Hydraulic Circuit: Port A/B Closed ● Supply Pressure : 14 MPa

● LSVG-03-4/10/20/40-10

Amplifier : AMLS-A-D48- * -10 (Power Supply: 48 V DC)
Input Signal $\pm 25\%$

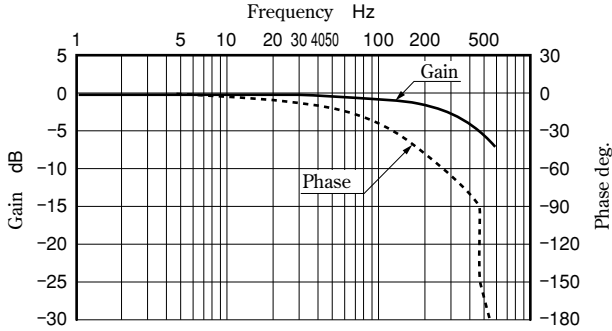

Input Signal $\pm 100\%$

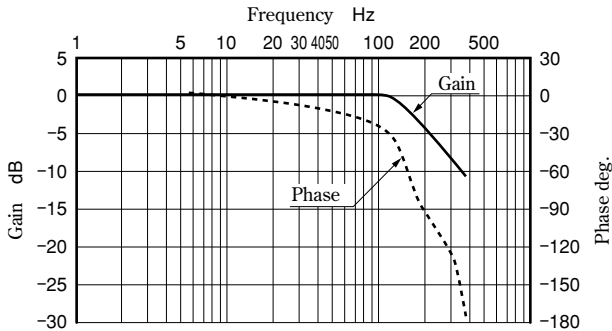

Amplifier : AMLS-A-D24- * -10 (Power Supply: 24 V DC)
Input Signal $\pm 25\%$

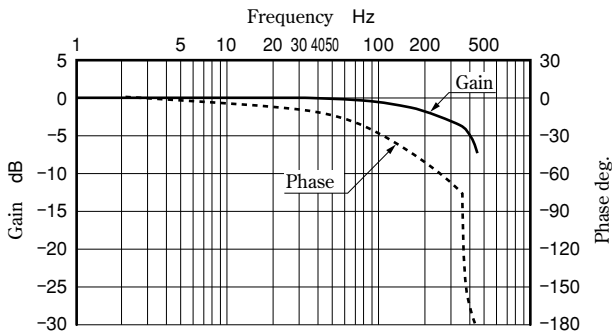

Input Signal $\pm 100\%$

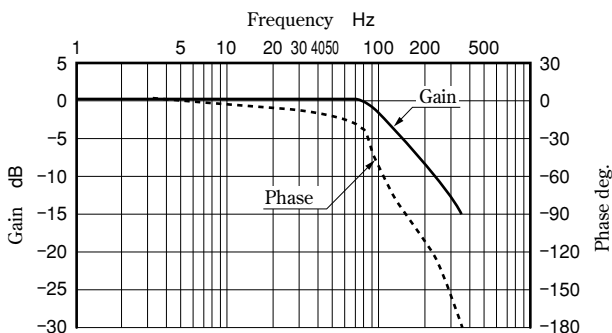

● LSVG-03-60-10

Amplifier : AMLS-B-D48- * -10 (Power Supply: 48 V DC)
Input Signal $\pm 25\%$

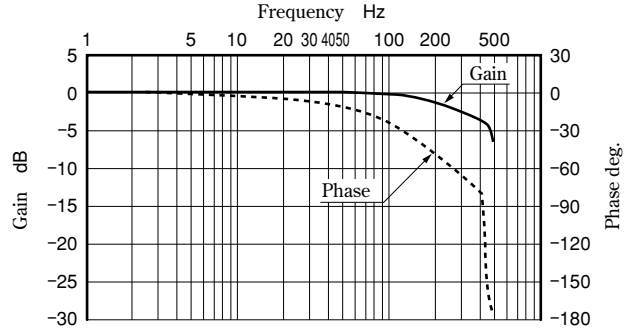

Input Signal $\pm 100\%$

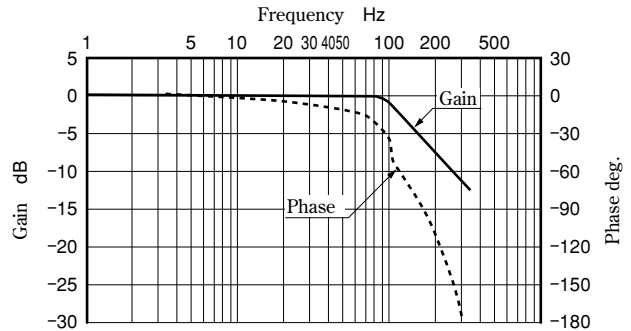

Amplifier : AMLS-B-D24- * -10 (Power Supply: 24 V DC)
Input Signal $\pm 25\%$

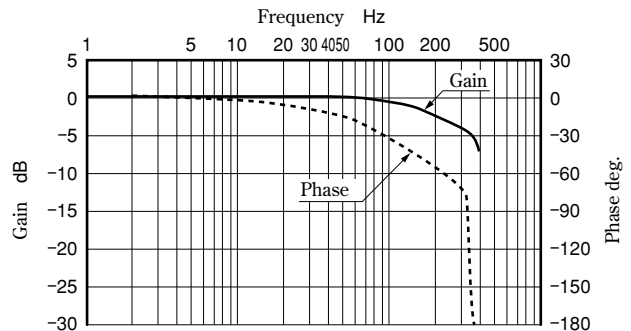

Input Signal $\pm 100\%$

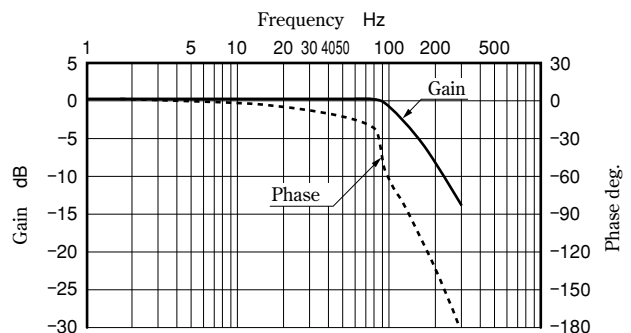

Tow Stage Type High-Speed Linear Servo Valves

Two stage type linear servo valves are a type of high-flow servo valve that has a direct type high speed linear servo valve in its pilot stage to drive the main spool. These valves control the positions of the pilot and main spools with electrical feedback, achieving high accuracy and response.

- **High flow**
The valves consist of two stages to provide a high flow rate (Rated flow at $\Delta P = 7$ MPa: 750 - 3800 L/min).
- **High accuracy**
The valves have a low hysteresis of 0.1 % or less, achieving high accuracy. They allow the main unit to operate with much higher repeatability.
- **High response characteristics**
The valves provide significantly high levels of step and frequency responses, which are typically used as measures of response characteristics; the step response is 8 ms (0 \leftrightarrow 100 %), and the frequency response is 105 Hz/90° (± 25 % amplitude) (Representative values for LSVHG-06-900). Thus, the valves ensure the achievement of unprecedented high response.
- **Excellent contamination resistance**
As is the case with the direct type linear servo valves, the permissible level of fluid contamination for these valves is up to NAS 1638 class 10.

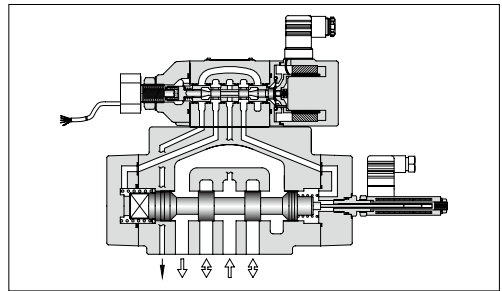
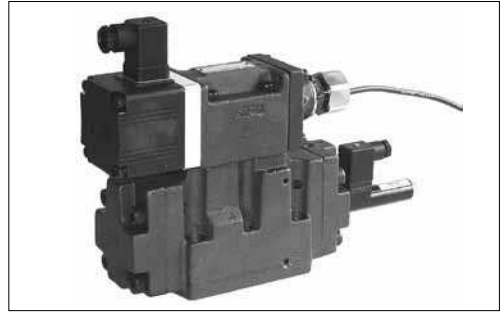

Graphic Symbols

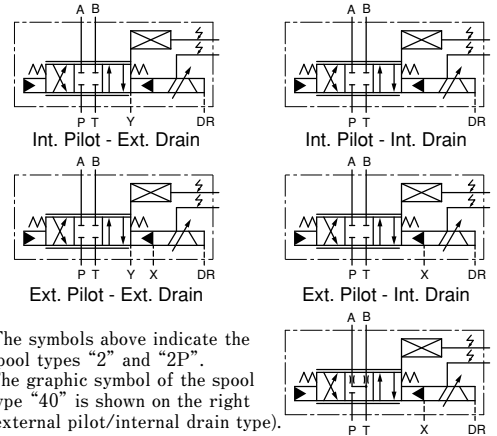

Note) The symbols above indicate the spool types "2" and "2P". The graphic symbol of the spool type "40" is shown on the right (external pilot/internal drain type).

Model Number Designation

F—	LSVHG	—06	—900	—2P	—E	T	—R	—A	—10
Fluid Type	Series Number	Valve Size	Rated Flow @ $\Delta P = 7$ MPa	Spool Type	Pilot Connection	Drain Connection	Cable Departure Direction	Fail-safe Function	Design Number
F : Special Seals for Phosphate Ester Type Fluid (Omit if not required)	LSVHG : Two Stage Type High Speed Linear Servo Valvesv	04	750 : 750 L/min	2 : 10% Overlap 	None : Internal Pilot E : External Pilot	None : External Drain T : Internal Drain	(Viewed from the linear motor side) None : Upper (Standard) R : Right L : Left	None : P→B→A→T Position Valve Opening: Full A : P→A→B→T Position Valve Opening: Full	10
		06	900 : 900 L/min 1300 : 1300 L/min	40 : Open Centre A, B & T 					20
		10	3800 : 3800 L/min	2P : Zero Lap (Dual Flow Gain)					

Exclusive Amplifiers

To ensure stable performance, it is recommended to use Yuken's AMLS series linear servo amplifiers.

Valve Model Number	Amplifier Model
LSVHG-04-750	AMLS-C2-D * - * -10
LSVHG-06-900	AMLS-C-D * - * -10
LSVHG-06-1300 LSVHG-10-3800	AMLS-D-D * - * -10

Attachment

Model Number	Mounting Bolt	Qty.	Bolt Tightening Torque
LSVHG-04	Hex. Soc. Head Cap Screw:M 6 ×55L	2	12.9 - 15.9 Nm
	Hex. Soc. Head Cap Screw:M10×60L	4	60.6 - 74.1 Nm
LSVHG-06	Hex. Soc. Head Cap Screw:M12×85L	6	104 - 127 Nm
LSVHG-10	Hex. Soc. Head Cap Screw:M20×90L	6	494 - 603 Nm

Specifications

The specifications below are for use with a 48 V DC type exclusive amplifier; for use with a 24 V DC type amplifier, see the values in parentheses ().

Description		Model Numbers		LSVHG-04-750			LSVHG-06-900			LSVHG-06-1300			LSVHG-10-3800		
Rated Flow @ $\Delta P = 7$ MPa (4-Way Valve)		L/min	750			900			1300			3800			
Rated Flow @ $\Delta P' = 0.5$ MPa (per Land)		L/min	283			340			490			1440			
Max. Operating Pressure		MPa	35			35			31.5			35			
Proof Pres. at Return Port	External Drain	MPa	31.5			35			25			28			
	Internal Drain ⁽¹⁾	MPa	31.5			35			25			28			
DR Port Permissible Back Pressure ⁽²⁾		MPa	0.05												
Pilot Pressure ⁽³⁾		MPa	1.5 - 35									1.5 - 25			
Pilot Flow Rate ⁽⁴⁾		L/min	27 (22) or more			30 (24) or more			34 (27) or more			32 (27) or more			
Pilot Valve Max. Leakage		Ps=Pp=14 MPa 32 mm ² /s	L/min												
Main Valve Max. Leakage		Spool Type	-2-	-40-	-2P-	-2-	-40-	-2P-	-2-	-40-	-2P-	-2-	-40-	-2P-	
		Ps=Pp=14 MPa 32 mm ² /s	L/min	0.8	1.6	6.8	0.9	1.8	7	1	2	8	3	6	10
Hysteresis		%	0.1 or less												
Step Response (0 <=> 100 %, Typical) ⁽⁵⁾		ms	8 (10)			8 (10)			10 (13)			15 (18)			
Frequency Response (± 25 % Amplitude, Typical) ⁽⁵⁾	Gain: -3 dB	Hz	150 (140)			160 (130)			150 (110)			100 (60)			
	Phase: -90°	Hz	110 (100)			105 (100)			100 (100)			85 (75)			
Vibration Proof ⁽⁶⁾		Frequency: 10 - 60 Hz, Amplitude: 4 mm, Acceleration: 7.8 - 282 m/s ² Frequency: 61 - 2000 Hz, Amplitude: 4 - 0.0038 mm, Acceleration: 294 m/s ²													
Protection		IP 64													
Ambient Temperature		°C	-15 - +60												
Spool Stroke to Stops		mm	± 5			± 5			± 7			± 7			
Spool End Area		cm ²	7.1			8			8			11.3			
Polarity		See the description about I/O signal characteristics on page 18.													
Linear Motor Specification	Current	A	2 [Max. 6]												
	Coil Resistance	Ω	4.5												
質量		kg	12			20			21			78			

Note: ⁽¹⁾ Pressure at the return port should be at actual supply pressure or less.

⁽²⁾ Back pressure at the drain port should be 0.05 MPa or less and not be a negative pressure.

⁽³⁾ Supply pressure for the pilot valve should be 1.5 to 35 MPa (1.5 to 25 MPa for LSVHG-10) and should also be 60 % of actual supply pressure or more.

⁽⁴⁾ The pilot flow is calculated based on a pilot pressure of 14 MPa and the above step response.

⁽⁵⁾ This value is measured for each valve based on a pilot pressure of 14 MPa; it may vary depending on the actual circuit/operation conditions.

⁽⁶⁾ There are restrictions on the mounting position; refer to the instructions for details.

LSVHG-04

The direction of the DIN connector can be changed by 90°.

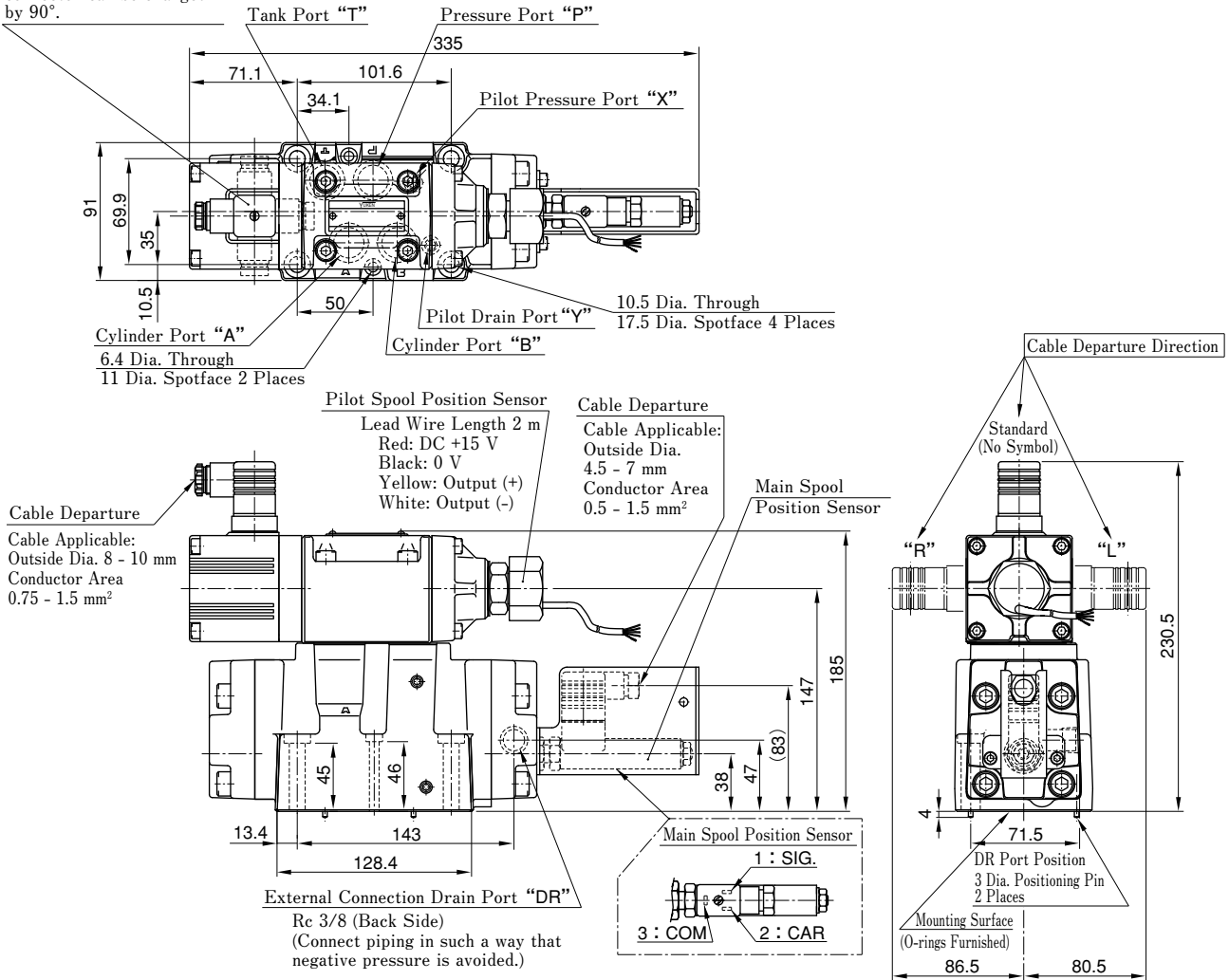

Note) Refer to the wiring diagram on page 20 for detailed connection between the pilot valve DIN connector/position sensors (pilot and main spools) and the amplifier.

[Mounting Surface]

Prepare a mounting surface shown on the right. Basically, the dimensions of the mounting surface conform to the ISO standard, but the specifications for the ports P, A, B, and T are different as follows.

	ISO 4401-07-06-0-94	Mounting Surface for LSVHG-04
Dia. of Port P, A, B, T	17.5 Dia.	20 Dia.

The mounting surface should have a good machined finish.

● O-rings for the Ports

Port	O-ring Size	Qty.
P, A, B, T	JIS B2401-1B-P22	4
X, Y	AS568-012 (NBR, Hs90)	2

O-rings made of fluorinated rubber are required to use phosphate ester type fluids.

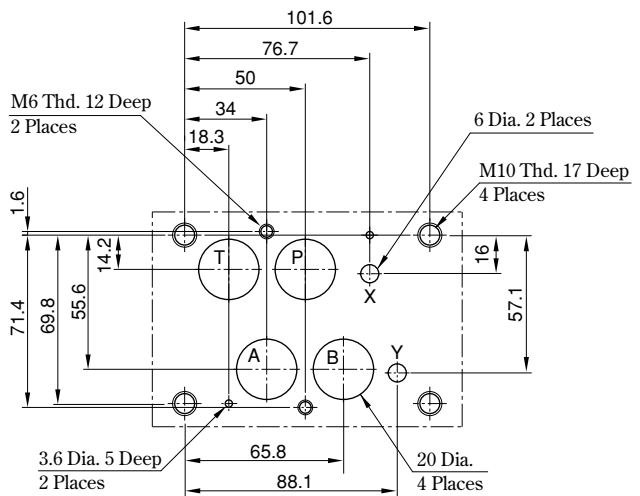

LSVHG-06

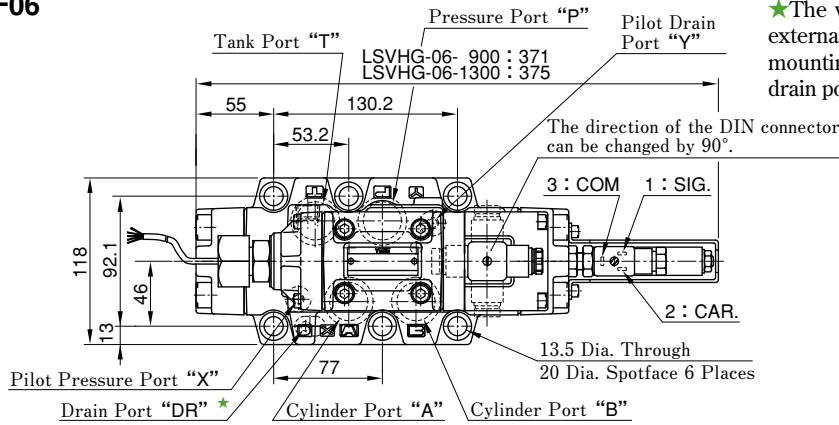

★The valve has two "DR" ports: one for external connection and the other on the mounting surface. Use either one of the drain ports.

Pilot Spool Position Sensor

Lead Wire Length 2 m
Red: DC +15 V
Black: 0 V
Yellow: Output (+)
White: Output (-)

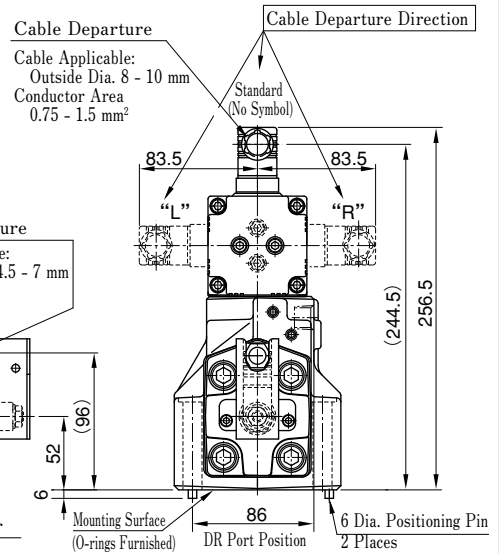
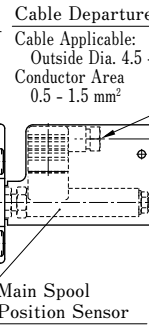
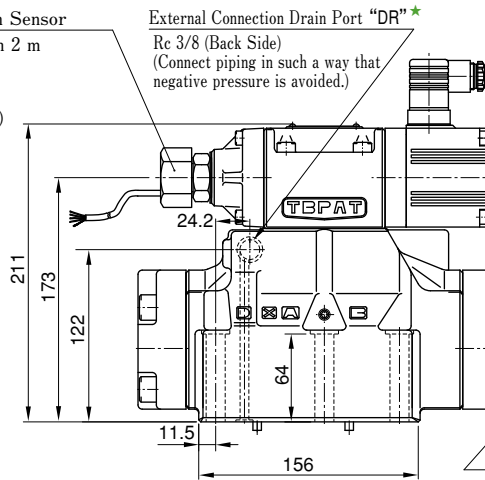

Note) Refer to the wiring diagram on page 20 for detailed connection between the pilot valve DIN connector/position sensors (pilot and main spools) and the amplifier.

【Mounting Surface】

Prepare a mounting surface shown on the right. Basically, the dimensions of the mounting surface conform to the ISO standard, but the specifications for the ports P, A, B, and T are different as follows.

	ISO 4401-08-07-0-94	Mounting Surface for LSVHG-06-900	Mounting Surface for LSVHG-06-1300
Dia. of Port P, A, B, T	23.4 Dia.	27 Dia.	32 Dia.
Drain Port	None	Available (6 Dia.)	

The mounting surface should have a good machined finish.

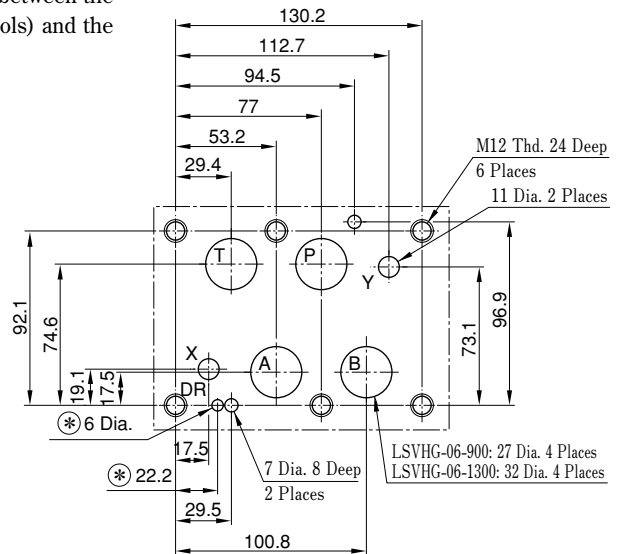

● O-rings for the Ports

Port	O-ring Size		Qty.
	LSVHG-06-900	LSVHG-06-1300	
P, A, B, T	AS568-123 (NBR, Hs90)	AS568-126 (NBR, Hs90)	4
X, Y	JIS B2401-1B-P14		2
DR	AS568-016 (NBR, Hs90)		1

O-rings made of fluorinated rubber are required to use phosphate ester type fluids.

Note) ⊗: Not required if the external connection drain port is used.

LSVHG-10

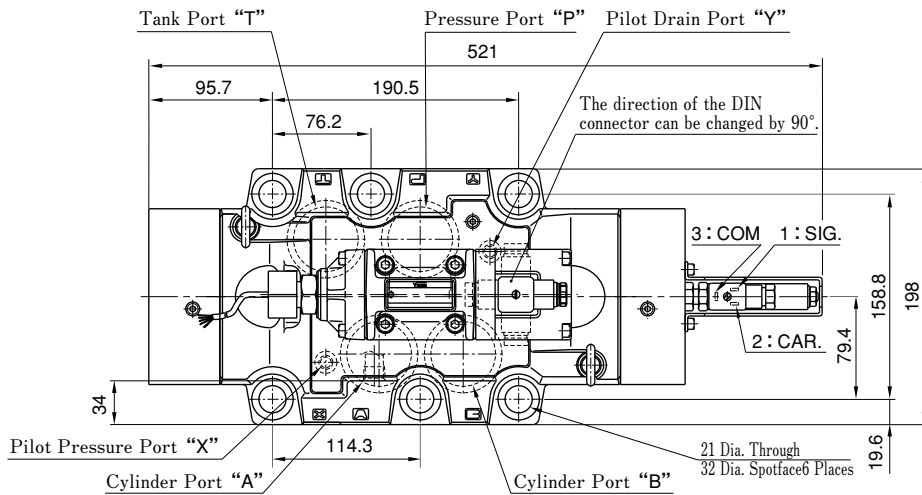

Pilot Spool Position Sensor

- Lead Wire Length 2 m
- Red: DC +15 V
- Black: 0 V
- Yellow: Output (+)
- White: Output (-)

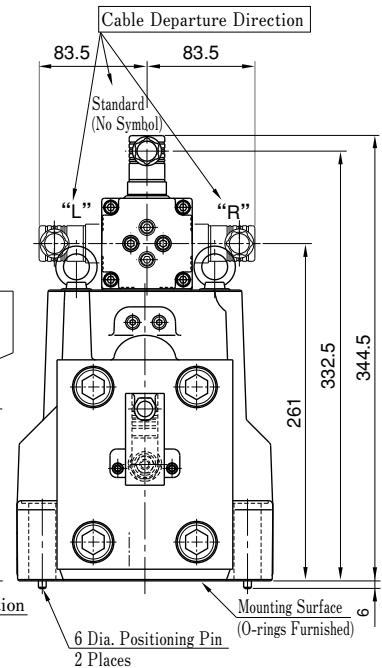
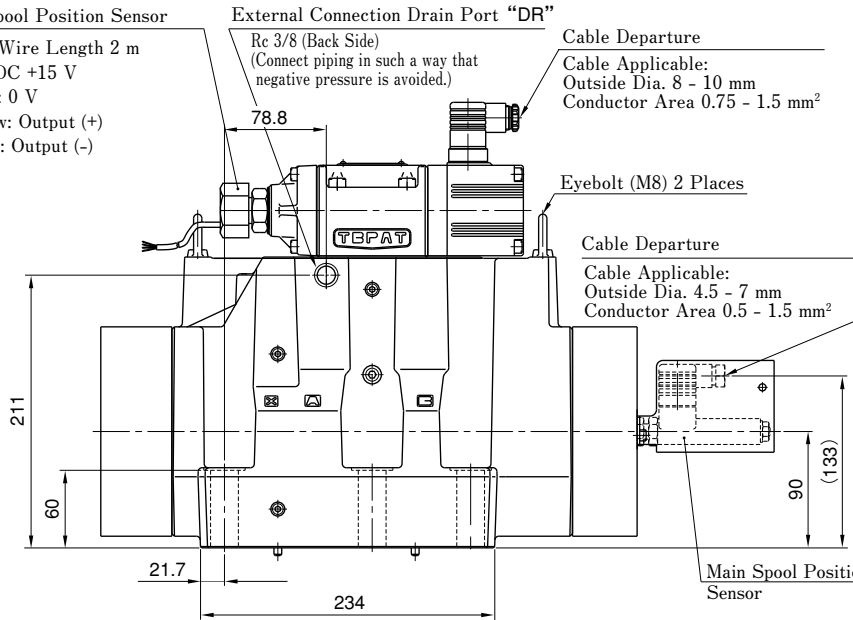

Note) Refer to the wiring diagram on page 20 for detailed connection between the pilot valve DIN connector/ position sensors (pilot and main spools) and the amplifier.

[Mounting Surface]

Prepare a mounting surface shown on the right. Basically, the dimensions of the mounting surface conform to the ISO standard, but the specifications for the ports P, A, B, and T are different as follows.

	ISO 4401-08-07-0-94	Mounting Surface for LSVHG-10
Dia. of Port P, A, B, T	36 Dia.	50 Dia.

The mounting surface should have a good machined finish.

● O-rings for the Ports

Port	O-ring Size	Qty.
P, A, B, T	AS568-227 (NBR, Hs 90)	4
X, Y	AS568-015 (NBR, Hs 90)	2

O-rings made of fluorinated rubber are required to use phosphate ester type fluids.

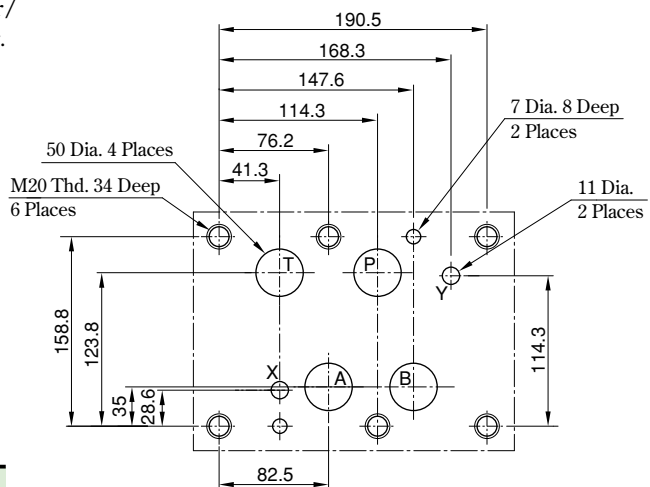

Characteristics of LSVHG-04-750 (Fluid Viscosity: 30 mm²/s)

No-Load Flow Characteristics

<Conditions> ● Valve Pressure Difference : 1 MPa (Pressure Difference per Land : 0.5 MPa)

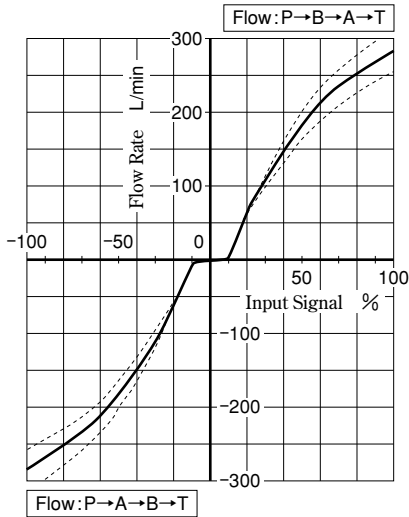

Around Null Position Input Signal -20 ↔ +20 %

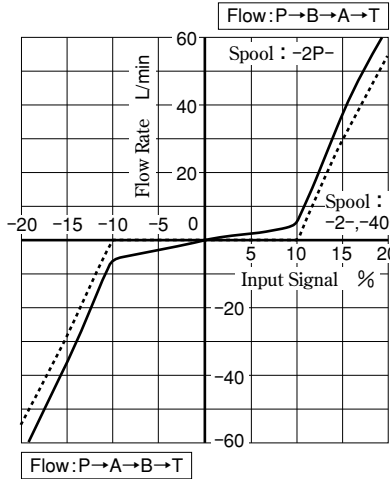

Load Flow Characteristics

<Conditions>

● Input Signal : 100 %

Note) Tolerance for Load Flow

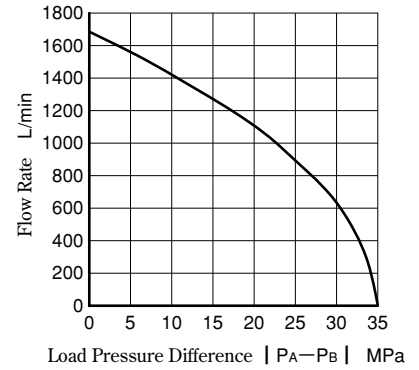

Step Response

<Conditions> ● Input Signal : 0 ↔ 100 % ● Supply/Pilot Pressure : 14 MPa

Amplifier: AMLS-C2-D48-* -10 (Power Supply: 48 V DC)

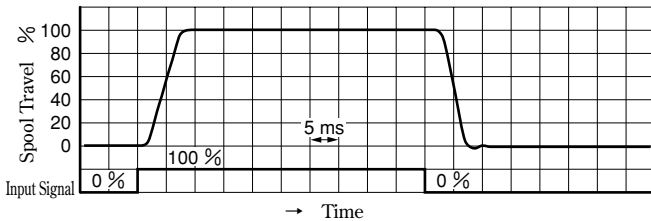

Amplifier: AMLS-C2-D24-* -10 (Power Supply: 24 V DC)

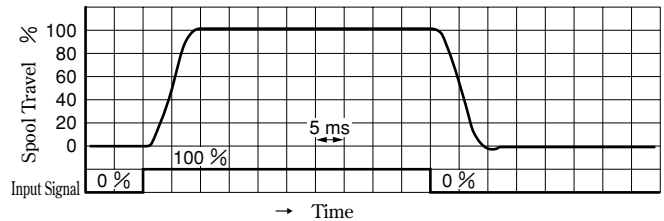

Frequency Response

<Conditions> ● Hydraulic Circuit: Port A/B Closed ● Supply/Pilot Pressure : 14 MPa

Amplifier: AMLS-C2-D48-* -10 (Power Supply: 48 V DC)

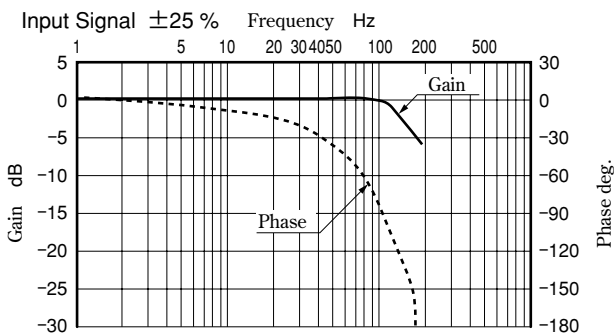

Amplifier: AMLS-C2-D24-* -10 (Power Supply: 24 V DC)

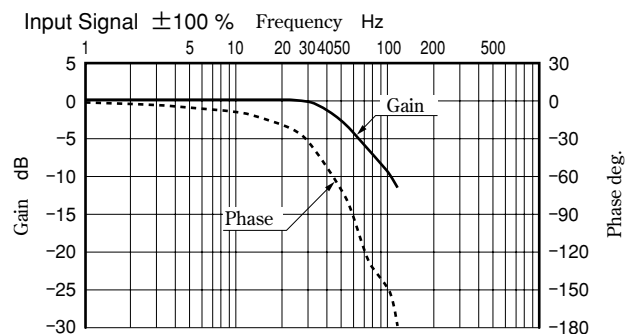
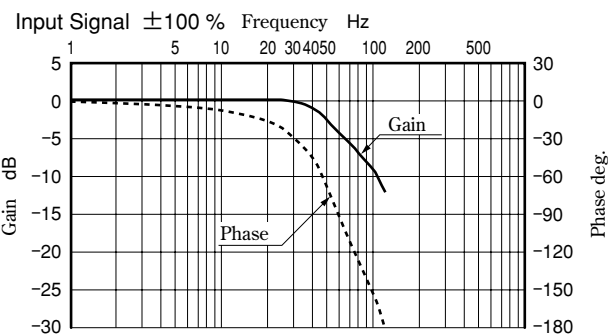
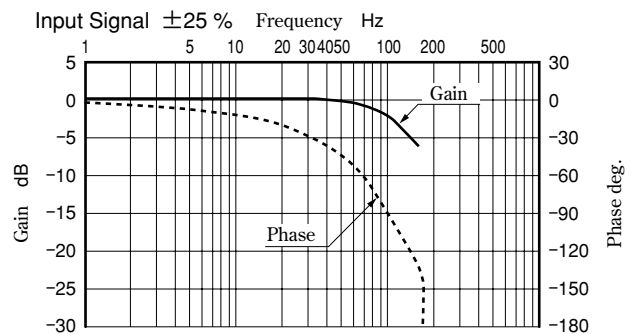

Characteristics of LSVHG-06-900 (Fluid Viscosity: 30 mm²/s)

No-Load Flow Characteristics

<Conditions> ● Valve Pressure Difference : 1 MPa (Pressure Difference per Land : 0.5 MPa)

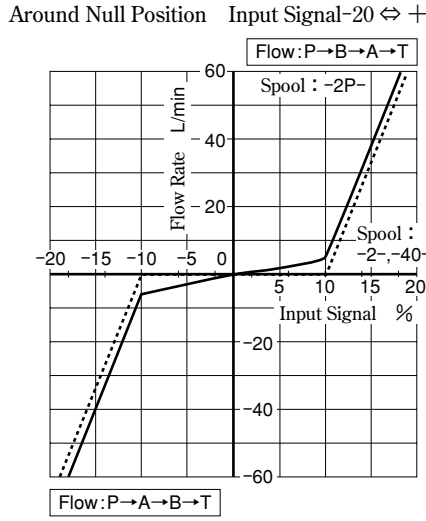
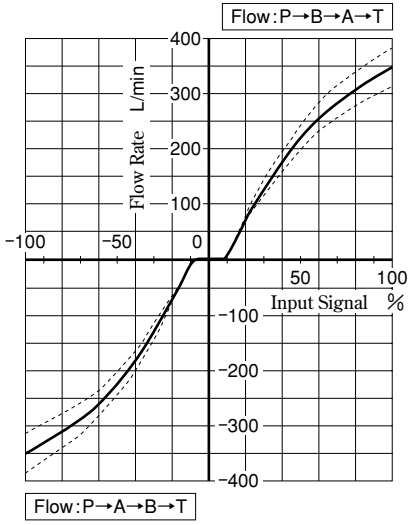

Load Flow Characteristics

<Conditions>

● Input Signal : 100 %

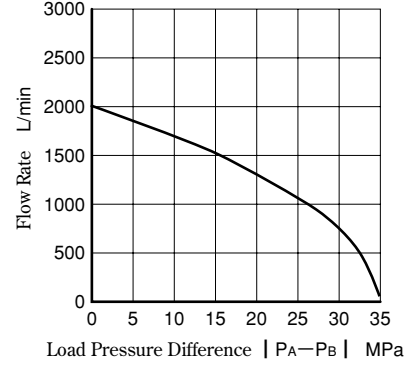

Step Response

<Conditions> ● Input Signal : 0 ⇔ 100 % ● Supply/Pilot Pressure : 14 MPa

Amplifier : AMLS-C-D48-* -10 (Power Supply: 48 V DC)

Amplifier: AMLS-C2-D24-* -10 (Power Supply: 24 V DC)

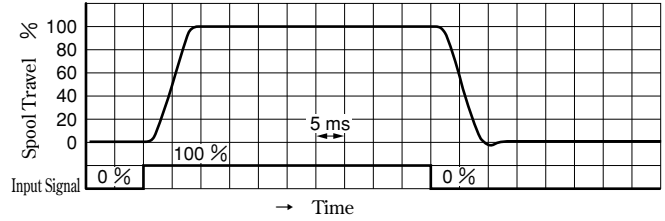
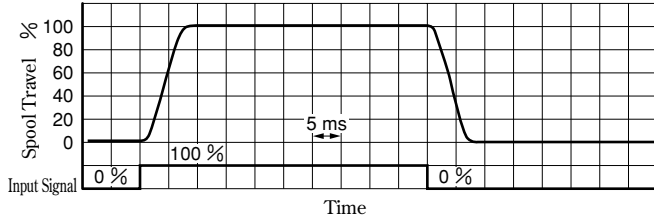

Frequency Response

<Conditions> ● Hydraulic Circuit: Port A/B Closed ● Supply/Pilot Pressure : 14 MPa

Amplifier : AMLS-C-D48-* -10 (Power Supply: 48 V DC)

Amplifier : AMLS-C-D24-* -10 (Power Supply: 24 V DC)

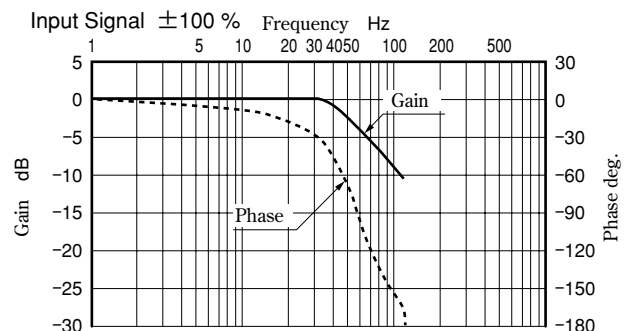
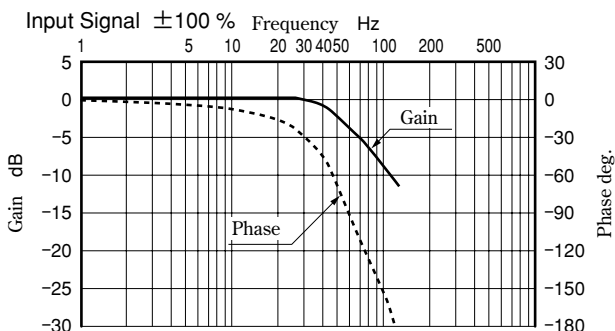
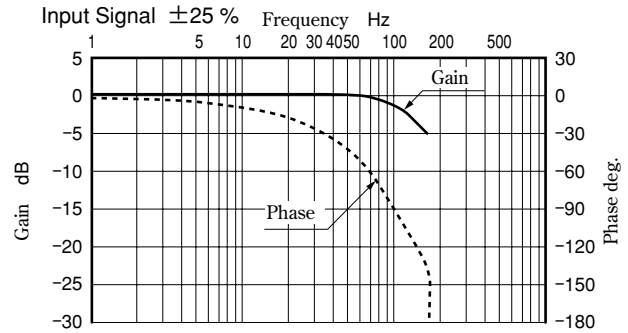
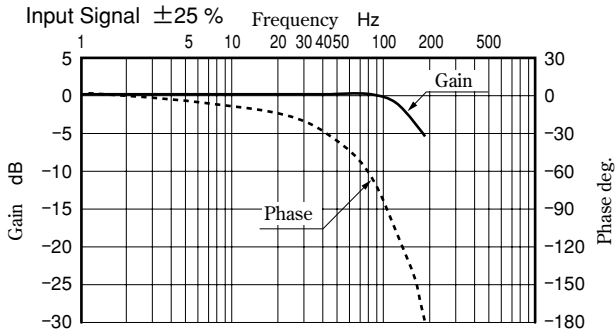

Characteristics of LSVHG-06-1300 (Fluid Viscosity: 30 mm²/s)

No-Load Flow Characteristics

<Conditions> ● Valve Pressure Difference: 1 MPa (Pressure Difference per Land : 0.5 MPa)

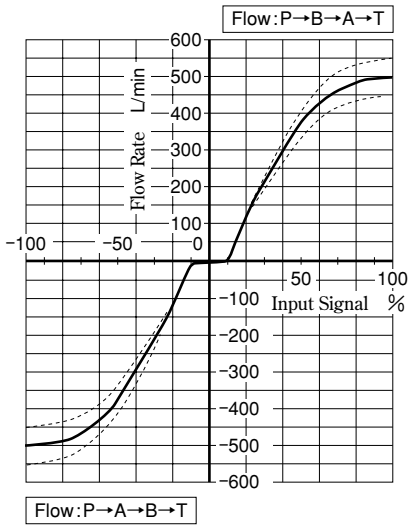

Around Null Position Input Signal -20 ⇔ +20 %

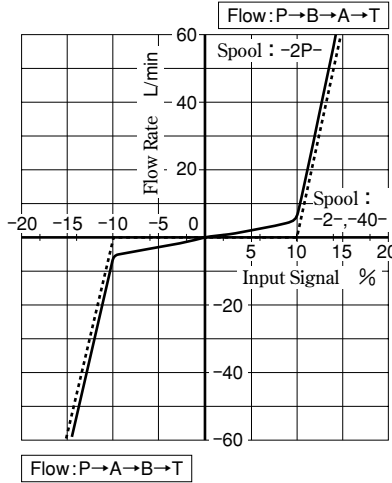

Load Flow Characteristics

<Conditions>

● Input Signal : 100 %

Note) Tolerance for Load Flow : ±10 %

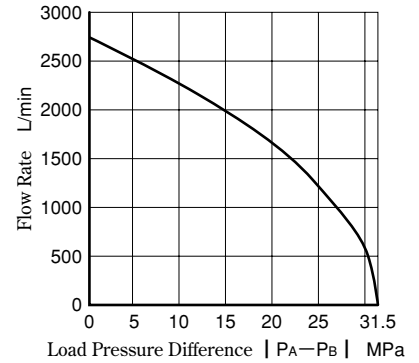

Step Response

<Conditions> ● Input Signal : 0 ⇔ 100 % ● Supply/Pilot Pressure : 14 MPa

Amplifier : AMLS-D-D48-* -10 (Power Supply: 48 V DC)

Amplifier : AMLS-D-D24-* -10 (Power Supply: 24 V DC)

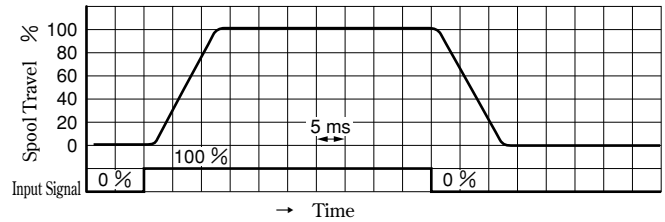
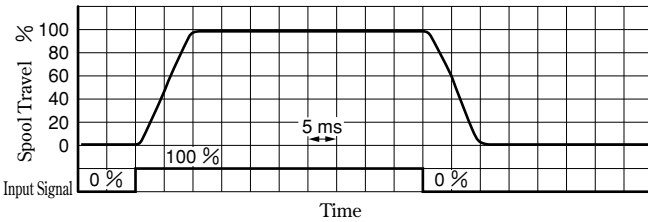

Frequency Response

<Conditions> ● Hydraulic Circuit: Port A/B Closed ● Supply/Pilot Pressure : 14 MPa

Amplifier : AMLS-D-D48-* -10 (Power Supply: 48 V DC)

Amplifier : AMLS-D-D24-* -10 (Power Supply: 24 V DC)

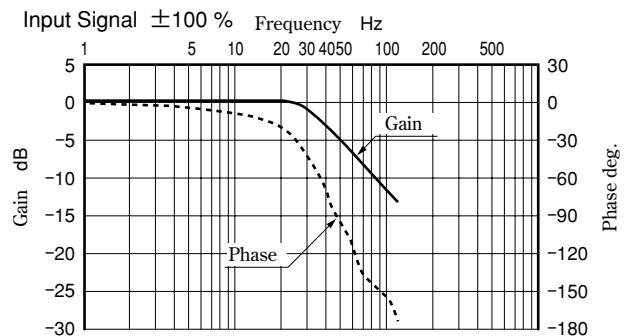
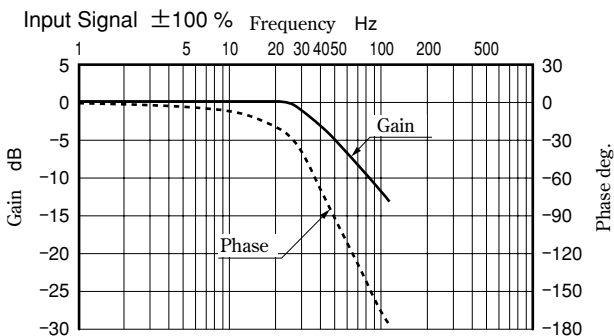
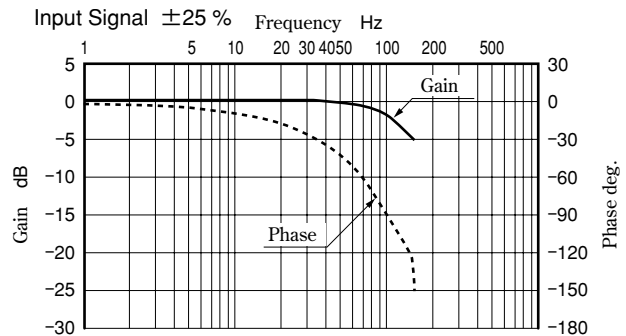
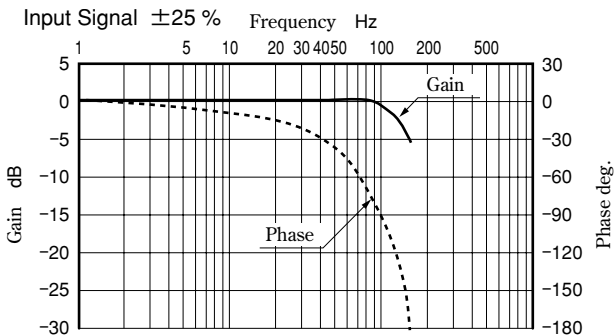

Characteristics of LSVHG-10-3800 (Fluid Viscosity: 30 mm²/s)

No-Load Flow Characteristics

<Conditions> ● Valve Pressure Difference : 1 MPa (Pressure Difference per Land : 0.5 MPa)

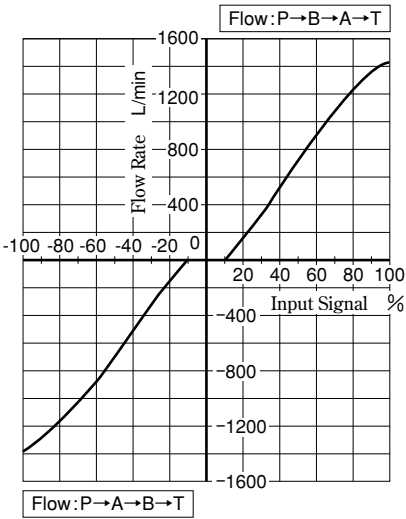

Around Null Position Input Signal -20 ⇔ +20 %

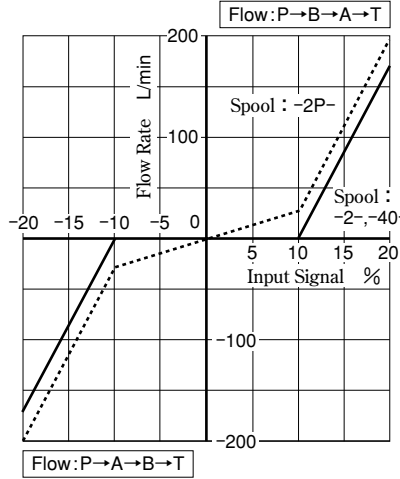

Flow: P→A→B→T

Load Flow Characteristics

<Conditions>

● Input Signal : 100 %

Note) Tolerance for Load Flow : ±10 %

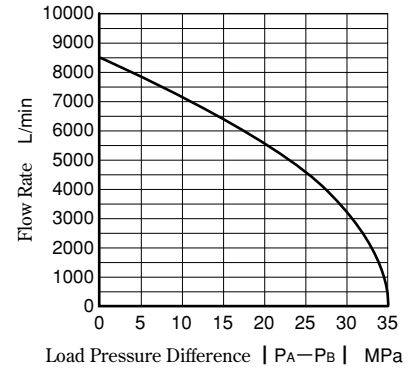

Step Response

<Conditions> ● Input Signal : 0 ⇔ 100 % ● Supply/Pilot Pressure : 14 MPa

Amplifier: AMLS-D-D48 * -10 (Power Supply: 48 V DC)

Amplifier: AMLS-D-D24 * -10 (Power Supply: 24 V DC)

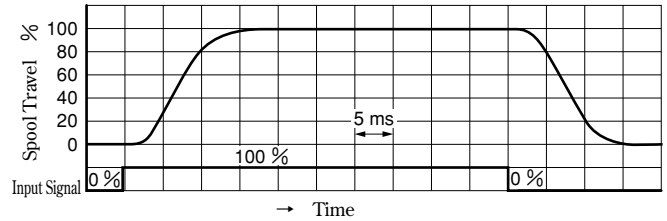
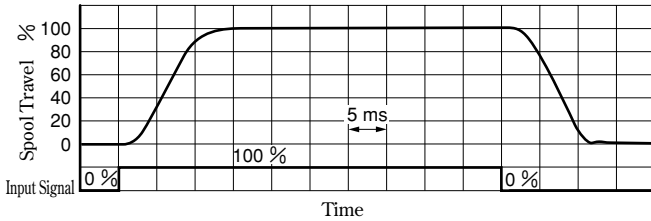

Frequency Response

<Conditions> ● Hydraulic Circuit: Port A/B Closed ● Supply/Pilot Pressure : 14 MPa

Amplifier: AMLS-D-D48 * -10 (Power Supply: 48 V DC)

Amplifier: AMLS-D-D24 * -10 (Power Supply: 24 V DC)

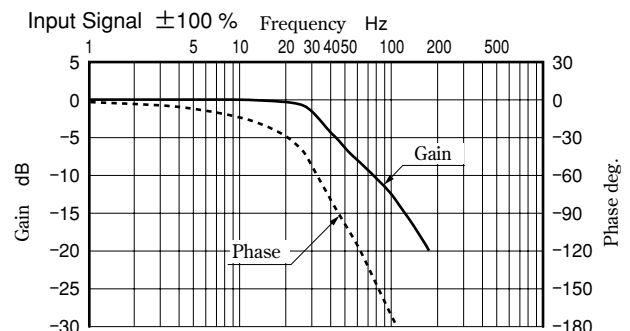
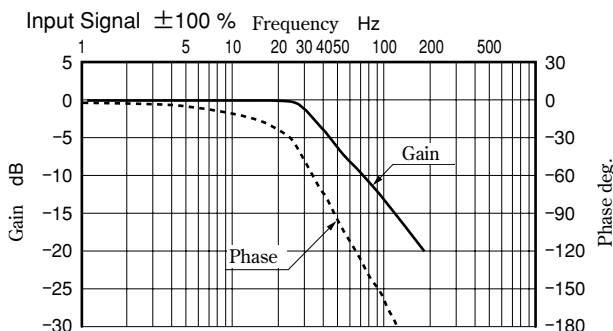
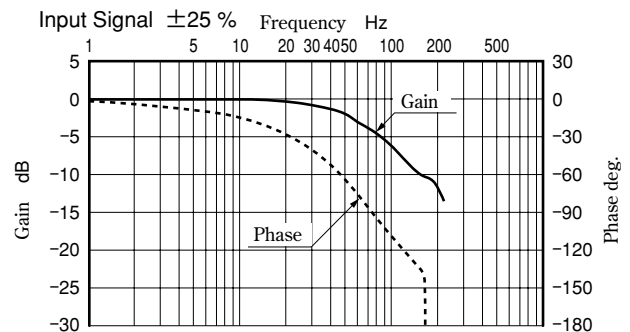
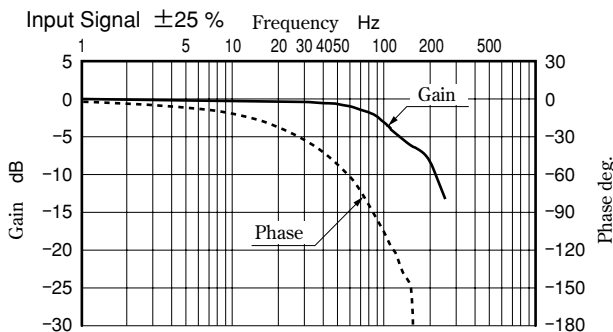

Linear Servo Amplifier

This amplifier is used to drive LSVG/LSVHG series high speed linear servo valves. With an optimal design for the servo valves, the amplifier can maximize the valve performance.



Specifications

Model Numbers	AMLS- *-D48- *-10	AMLS- *-D24- *-10
Description		
Power Supply	48 V ± 2.4 V DC (200 VA or more)	24 V ± 1.2 V DC (100 VA or more)
Rated Output Current	Continuous ±2 A (4 A Peak)	Continuous ±2 A (3 A Peak)
Input/Output Signal	Output Signal = Spool Travel Monitoring A1 : Voltage Signal ±10 V (R _i = 100 kΩ, R _L ≥ 10 kΩ) B1 : Current Signal 4 - 20 mA (R _i = 200 Ω, R _L = 100 - 500 Ω) C1 : Current Signal ±10 mA (R _i = 200 Ω, R _L = 100 - 500 Ω)	
Control Input /Output Signal	a) Servo "ON" Input/Alarm Reset Input: Photocoupler Input Voltage: +15 V DC to +28 V DC, Input Impedance: 2.2 kΩ b) Overcurrent Output (CURR.AL.)/Deviation Alarm Output (CRTL.AL.): Photocoupler Output Voltage: Max. 50 V DC, Current: Max. 30 mA	
Ambient Temperature	0 - 50 °C	
Ambient Humidity	20 - 90 %Rh (No Condensation)	
Mass	1.8 kg	

Model Number Designation

AMLS	-A	-D48	-A1	-10
Series Number	Applicable Valve Type	Supply Voltage	Input Signal/ Spool Travel Monitoring	Design Number
AMLS : Linear Servo Amplifier	A : LSVG-03-4/10/20/40 B : LSVG-03-60 C : LSVHG-06-900 C2 : LSVHG-04 D : LSVHG-06-1300 LSVHG-10-3800	D48 : DC 48 V D24 : DC 24 V	A1: Voltage Signal ±10 V B1: Current Signal 4 - 20 mA C1: Current Signal ±10 mA	10

I/O Signal Characteristics

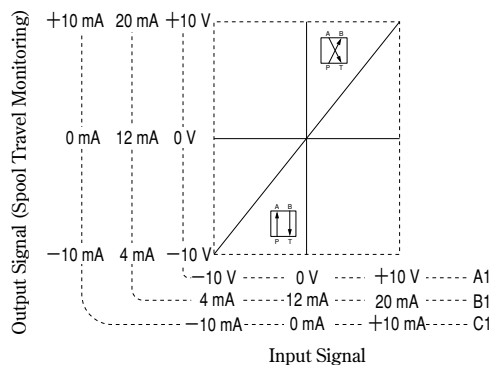

Appearance/Terminal Names

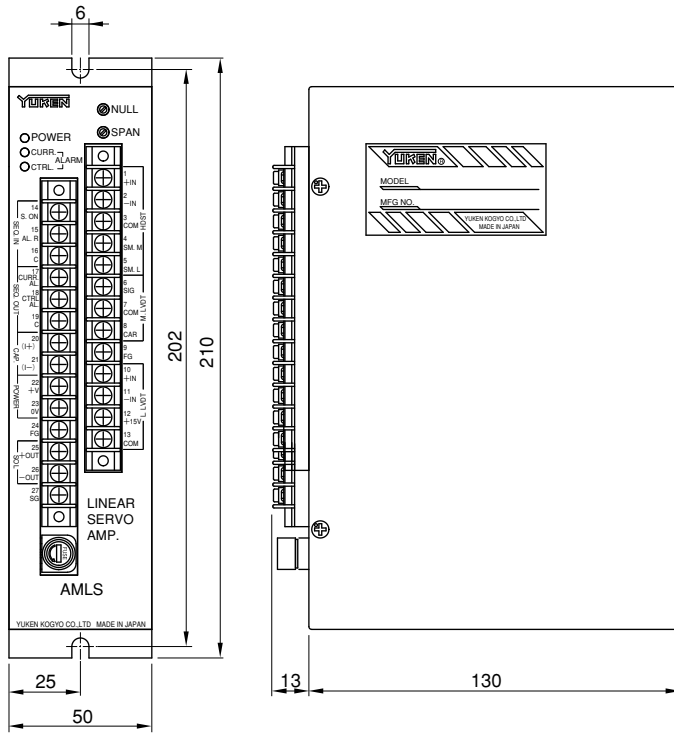

● Terminal Name

No.	Terminal Name	
1	Input Signal	+IN
2		-IN
3	Common	COM
4	Sensor	Main Valve Spool
5	Monitoring	Pilot Valve/Direct Type Linear Servo Valve
6		SIG
7	Main Valve Spool Travel Sensor	COM
8		CAR
9	Frame Grounding	FG
10		+IN
11	Spool Travel Sensor for Pilot	-IN
12	Valve/Direct Type Linear Servo Valve	+15V
13		COM
14	Sequence	Servo ON
15	Input	Alarm Reset
16		Input Common
17	Sequence	Overcurrent Alarm
18	Output	Deviation Alarm
19		Output Common
20	Capacitor Connection Terminal	Cap.(+)
21		Cap.(-)
22	Power Supply	+V
23		0V
24	Frame Grounding	FG
25	SOL Output	+OUT
26		-OUT
27	Signal Grounding	SG

Block Diagram

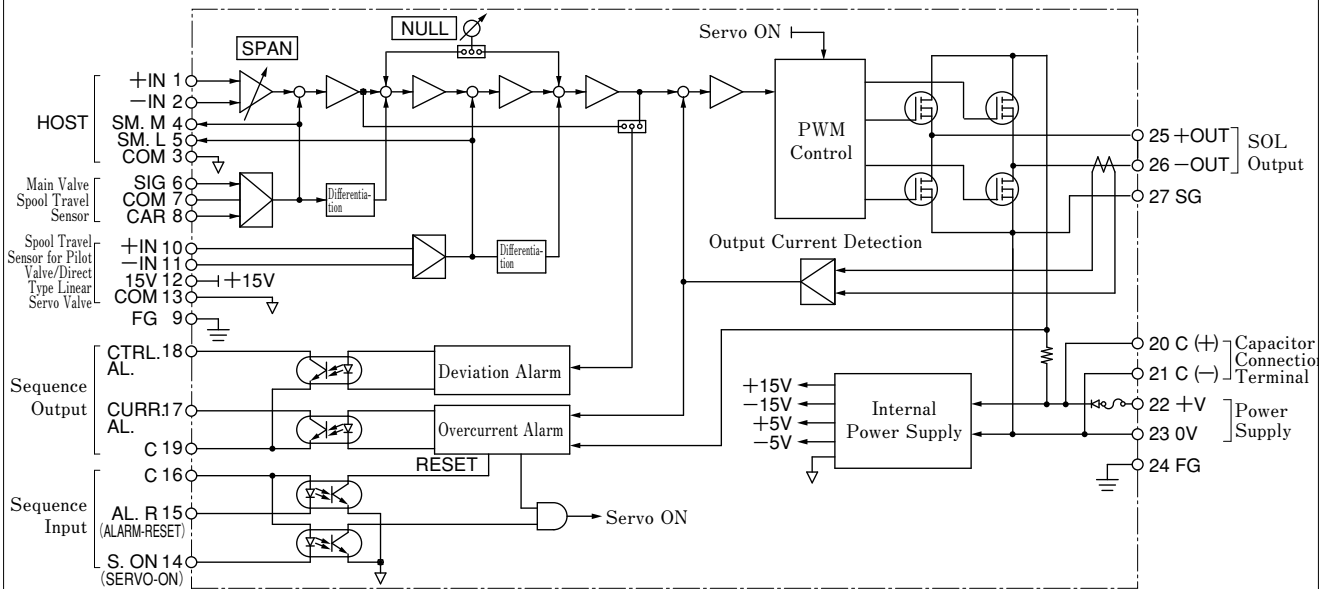

Wire Connection Diagram

● AMLS-A, AMLS-B

* To hold the valve spool at the neutral position for a few seconds upon power failure or after power-off, connect the capacitor between C (+) and C (-) (terminal blocks 20 and 21).

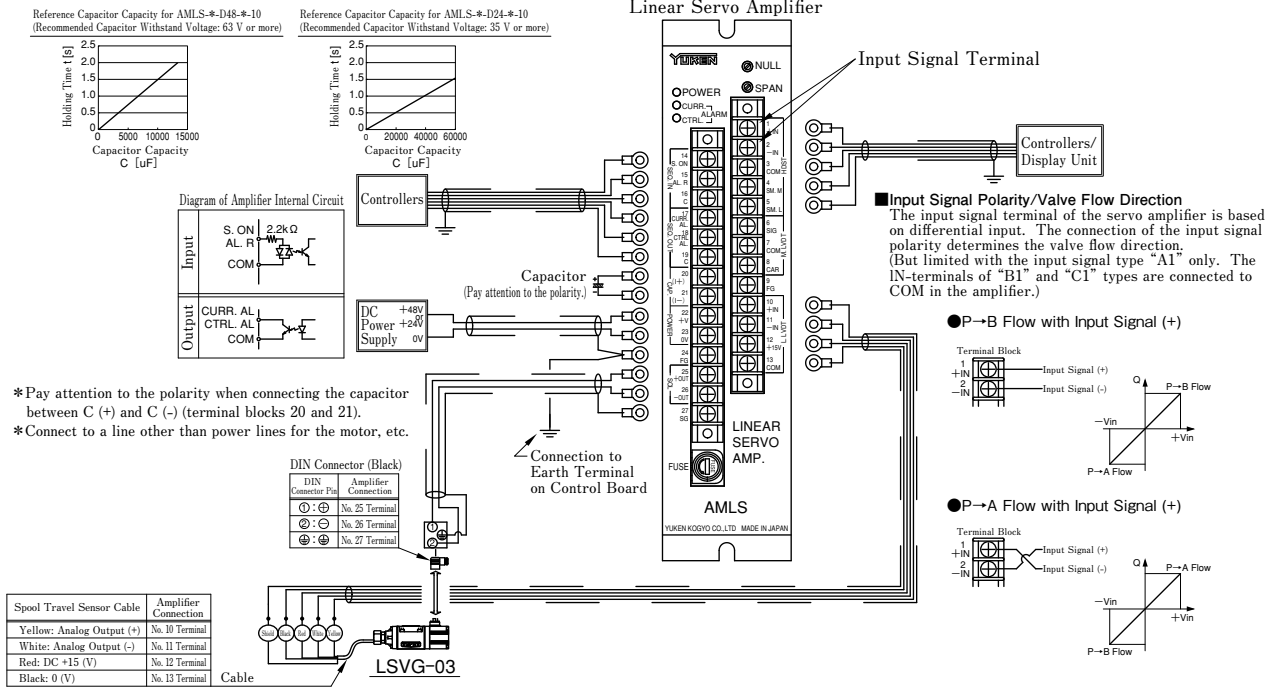

● AMLS-C, AMLS-C2, AMLS-D

* To hold the valve spool at the neutral position for a few seconds upon power failure or after power-off, connect the capacitor between C (+) and C (-) (terminal blocks 20 and 21).

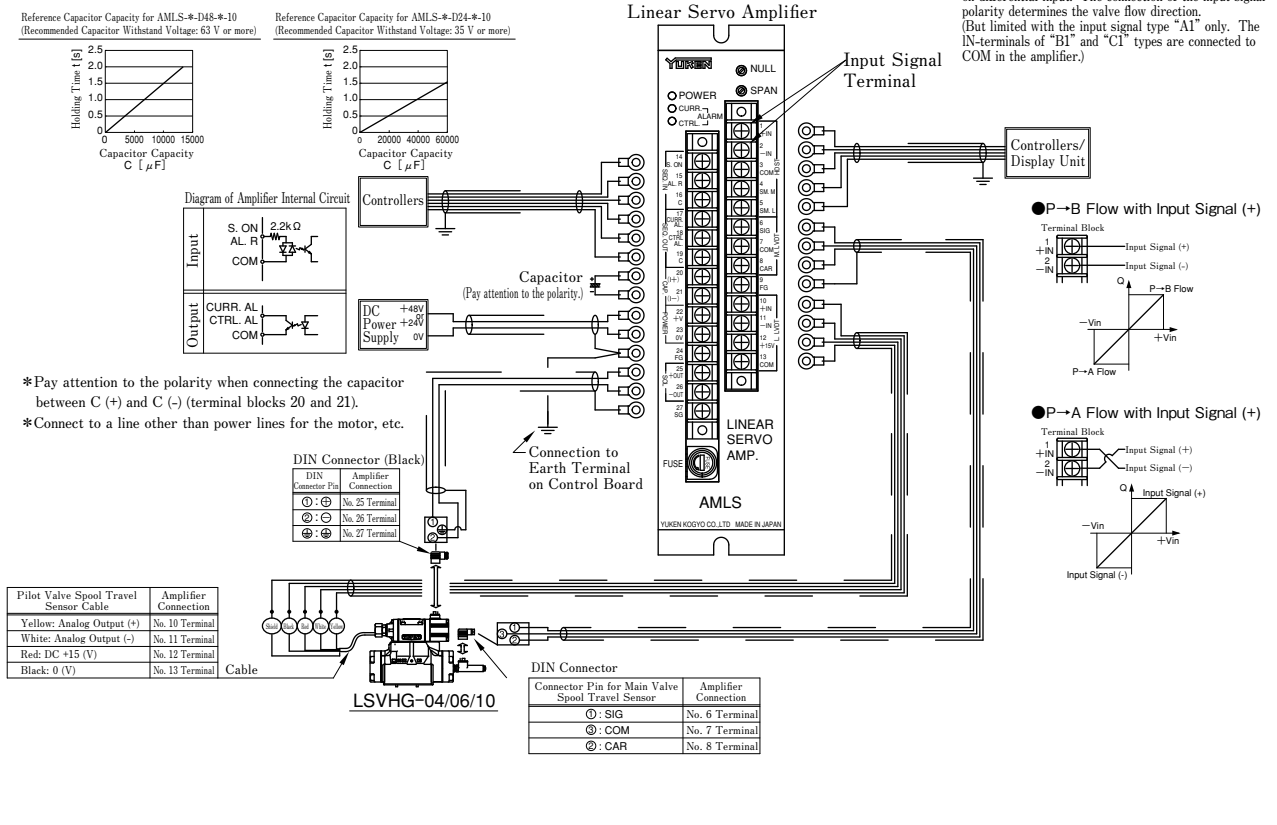

OBE type Direct Operated Linear Servo Valves

On-board electronics (OBE) type direct operated linear servo valves are based on high speed linear servo valves (LSVG) and OBE type linear servo valves (LSVHG-*EH), providing "high accuracy, easiness to use, and great usability" .

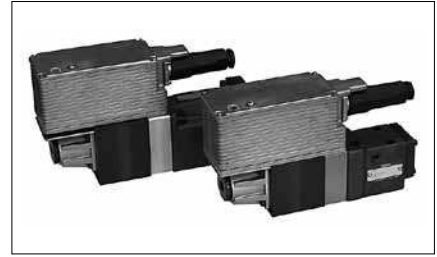

● **High accuracy**

As is the case with the high speed linear servo valves, all of the OBE type direct operated linear servo valves have a low hysteresis of 0.1 % or less, realizing high accuracy. These valves allow the main unit to operate with much higher repeatability.

● **High response characteristics**

Compared to other equivalent models, these valves provide higher levels of step and frequency responses, which are typically used as measures of response characteristics; the step response is 3 ms (0 <=> 100 %)★, and the frequency response is 260 Hz/-3 dB (± 25 % amplitude)★.

[★ : Representative values for LSVG-03EH with the Y port (dry type)]

● **Easiness to use**

These valves can offer high accuracy for hydraulic control systems just with 24 V DC power supply and command signal input.

Six types of input signals in three input voltage/current ranges are available: 0 - ±10 V, 0 - ±10 mA, and 4 - 20 mA.

● **Great usability**

The small amplifier in the valves has a fault indicator lamp. This lamp indicates an error when valve failure causes any deviation between the spool position commanded by the signal and the actual spool position. It facilitates you to immediately troubleshoot the failure of the valves, if any.

● **Excellent contamination resistance**

As is the case with the high speed linear servo valves, the OBE type direct operated linear servo valves have a simple pilot valve structure, exhibiting excellent contamination resistance. The permissible level of fluid contamination for these valves is up to NAS 1638 class 10.

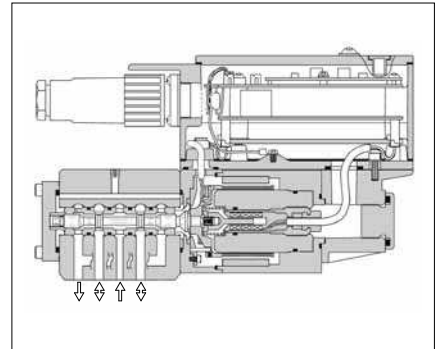

Graphic Symbols

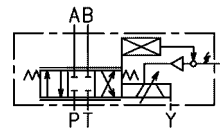

With Y Port (Dry Type)

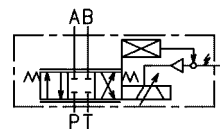

Without Y Port (Wet Type)

■ **Model Number Designation**

F-	LSVG	-03	EH	-60	-W	A	-A	1	-10
Fluid Type	Series Number	Valve Size	Amp. Type	Rated Flow @ ΔP=7MPa	Drain Port and Permissible Back Pres.	Fail-safe Function	Input Signal/Spool Travel Monitoring	Connector Type	Design Number
F : Special Seals for Phosphate Ester Type Fluid (Omit if not required)	LSVG : Direct Operated Linear Servo Valves	01	EH : OBE Type	4: 4 L/min	None: With Y Port (Permissible Back Pres.: 0.05 MPa) (Dry Type)	A: P→A→B→T Position B: P→B→A→T Position C:Neutral	A: Voltage Signal ±10 V (P→B→A→T Flow with Input Signal (+))	1: 6 + PE Pole 2: 11 + PE Pole - With "Enable" Function - With "Valve Ready" Function - With "Alarm Output" Function	10
				10: 10 L/min			B: Current Signal 4 - 20 mA (P→B→A→T Flow with Current Signal 12 - 20 mA)		
		03		20: 20 L/min	W: Without Y Port★ (Wet Type)		C: Current Signal ±10 mA (P→B→A→T Flow with Input Signal (+))		
				40: 40 L/min			D: Voltage Signal ±10 V (P→A→B→T Flow with Input Signal (+))		
				60: 60 L/min			E: Current Signal 4 - 20 mA (P→A→B→T Flow with Current Signal 12 - 20 mA)		10
							F: Current Signal ±10 mA (P→A→B→T Flow with Input Signal (+))		1006 (Mounting bolt: M6)

★ For the wet type, water-glycol fluids cannot be used.

Specifications The values in parentheses in the specification table below are applicable to the models "LSVG-*EH-*-W*-" (wet type).

Model Numbers		LSVG-01EH-4-*	LSVG-01EH-10-*	LSVG-01EH-20-*	LSVG-03EH-40-*	LSVG-03EH-60-*
Description						
Rated Flow at $\Delta P = 7 \text{ MPa}$ ⁽¹⁾	L/min	4	10	20	40	60
Max. Operating Pressure	MPa	35			35 ⁽²⁾	
Proof Pres. at Return Port	MPa	21 (7)			35 ⁽²⁾ (7)	
Drain Port (Y Port) Permissible Back Pres. ⁽³⁾	MPa	0.05 (No Y Port for Wet Type)				
Internal Leakage ($P_s = 14 \text{ MPa}$ Max. Leakage Viscosity: $32 \text{ mm}^2/\text{s}$)	L/min	0.4 or less	0.8 or less	1.2 or less	1.7 or less	
Hysteresis	%	0.1 or less				
Step Response (Typical) ⁽⁴⁾	$P_2 = 14 \text{ MPa}$ ($0 \leftrightarrow 100 \%$)	3 (3.5)				4 (4.5)
Frequency Response ($\pm 25 \%$ Amplitude) (Typical) ⁽⁴⁾	Gain: -3 dB	240 (230)			260 (240)	250 (220)
	Phase: -90°	300 (270)			310 (310)	260 (220)
Vibration Proof	m/s^2	100				
Protection		IP 65				
Ambient Temperature	$^\circ\text{C}$	0 - + 50				
Spool Stroke to Stops	mm	± 0.5				± 0.75
Polarity		See the description about I/O signal characteristics on page 23.				
Linear Motor Specification	Current	1.5 (Max. 3.2)				
	Coil Resistance	Ω 7 at 20°C				
Approx. Mass	kg	4.3			5.2	
Electric Connection		6 + PE/11 + PE Connector				

Note: ⁽¹⁾ Use the valves so that the relationship between the valve pressure difference and the flow rate, as specified below in "Range of Flow Control", is met.

⁽²⁾ For LSVG-03EH-*-*-*1006 (mounting bolt: M6), the pressure should be 31.5 MPa.

⁽³⁾ Back pressure at the drain port (Y) should be 0.05 MPa or less and not be a negative pressure.

⁽⁴⁾ This value is measured for each valve; it may vary depending on the actual circuit/operation conditions.

Attachment

Mounting Bolts

Model Number	Mounting Bolt	Qty.	Bolt Tightening Torque
LSVG-01EH	Hex. Soc. Head Cap Screw : M5×55 L	4	6.0 - 8.0 Nm
LSVG-03EH-*10	Hex. Soc. Head Cap Screw : M8×65 L	4	30.8 - 37.7 Nm
LSVG-03EH-*1006	Hex. Soc. Head Cap Screw : M6×60 L	4	13.0 - 16.0 Nm

Connector

Model Number	Connector	Qty.	Remarks
LSVG-*EH-*-*1	6 + PE Electrical Plug	1	Compatible with EN 175201 PART 804
LSVG-*EH-*-*2	11 + PE Electrical Plug	1	

Cable with Connector (Separately Available)

Model Number	Connector	Cable Model Number	Remarks
LSVG-*EH-*-*1	6 + PE Electrical Plug	LSVC-6PE-*10	* Cable Length 03 : 3 m 05 : 5 m 10 : 10 m
LSVG-*EH-*-*2	11 + PE Electrical Plug	LSVC-12PE-*10	

The cable with a connector is a cable assembly that includes the same connector as the one supplied with the valves.

Range of Flow Control

Control Method: 4-Way Valve

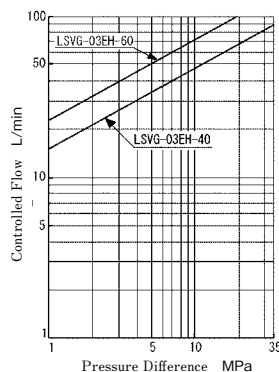
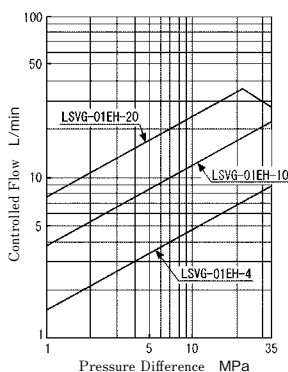

Control Method: 3-Way Valve

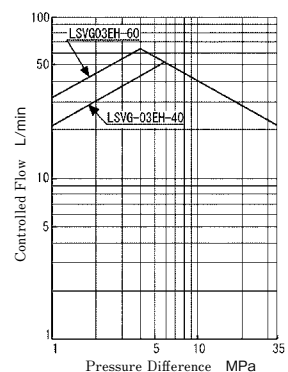
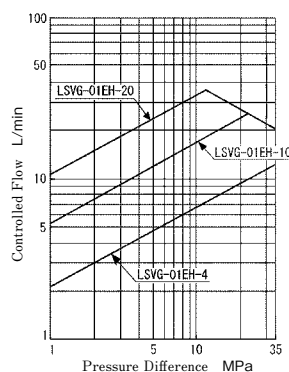

Electrical Specifications

6 + PE Connector

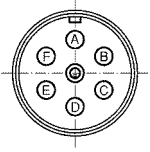

Pin		Valve Model		
		LSVG-*EH-*-A1 LSVG-*EH-*-D1	LSVG-*EH-*-B1 LSVG-*EH-*-E1	LSVG-*EH-*-C1 LSVG-*EH-*-F1
Pin A	Power Supply	24 V DC (21.6 - 26.4 V DC Included Ripple), 100 VA or more		
Pin B		0 V		
Pin C	Signal Common	COM(0 V)		
Pin D	Input (+) (Differential) ^{*1}	0 - ±10 V Ri=100 kΩ	4 - 20 mA Ri=200 Ω	0 - ±10 mA Ri=200 Ω
Pin E	Input (-) (Differential) ^{*1}			
Pin F	Spool Travel Monitoring	0 - ±10 V Ri ≥ 10 kΩ	4 - 20 mA Ri = 100~500 Ω ^{*2}	0 - 10 mA Ri = 100~500 Ω ^{*2}
Pin	Protective Earth	-		

11 + PE Connector

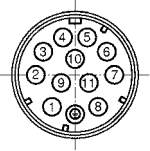

Pin		Valve Model		
		LSVG-*EH-*-A2 LSVG-*EH-*-D2	LSVG-*EH-*-B2 LSVG-*EH-*-E2	LSVG-*EH-*-C2 LSVG-*EH-*-F2
Pin 1	Power Supply	24 V DC (21.6 - 26.4 V DC Included Ripple), 100 VA or more		
Pin 2		0 V		
Pin 3	Enable (Servo ON) Input	Input Current = 3 - 5 mA at 4.8 - 28 V DC		
Pin 4	Input (+) (Differential) ^{*1}	0 - ±10 V Ri=100 kΩ	4 - 20 mA Ri=200 Ω	0 - ±10 mA Ri=200 Ω
Pin 5	Input (-) (Differential) ^{*1}			
Pin 6	Spool Travel Monitoring	0 - ±10 V Ri ≥ 10 kΩ	4 - 20 mA Ri = 100 - 500 Ω ^{*2}	0 - ±10 mA Ri = 100 - 500 Ω ^{*2}
Pin 7	Signal Common	COM (0 V)		
Pin 8	Valve Ready Output	Open Collector Output Voltage: Max. 30 V, Current: Max. 20 mA		
Pin 9	-	-		
Pin 10	-	-		
Pin 11	Alarm Output	Open Collector Output Voltage: Max. 30 V, Current: Max. 20 mA		
Pin	Protective Earth	-		

^{*1}. Differential input signals can be used only for the valves with the voltage signal specifications of ±10 V (LSVG-*EH-*-A*/D*).

^{*2}. The recommended load resistance is 200 Ω.

I/O Signal Characteristics

· LSVG-*EH-*-A*/B*/C*

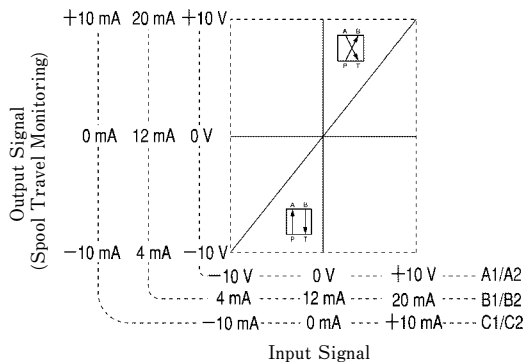

· LSVG-*EH-*-D*/E*/F*

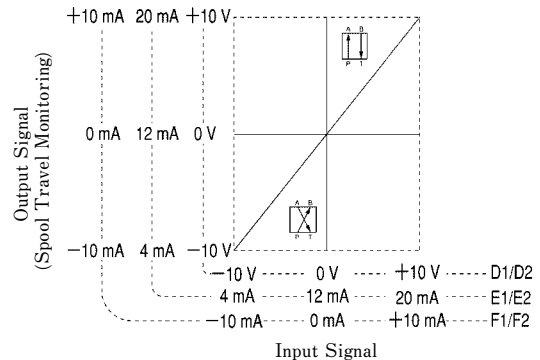

Block Diagram

● LSVG-*EH-*-* *-A1/B1/C1/D1/E1/F1 (6 + PE Connector)

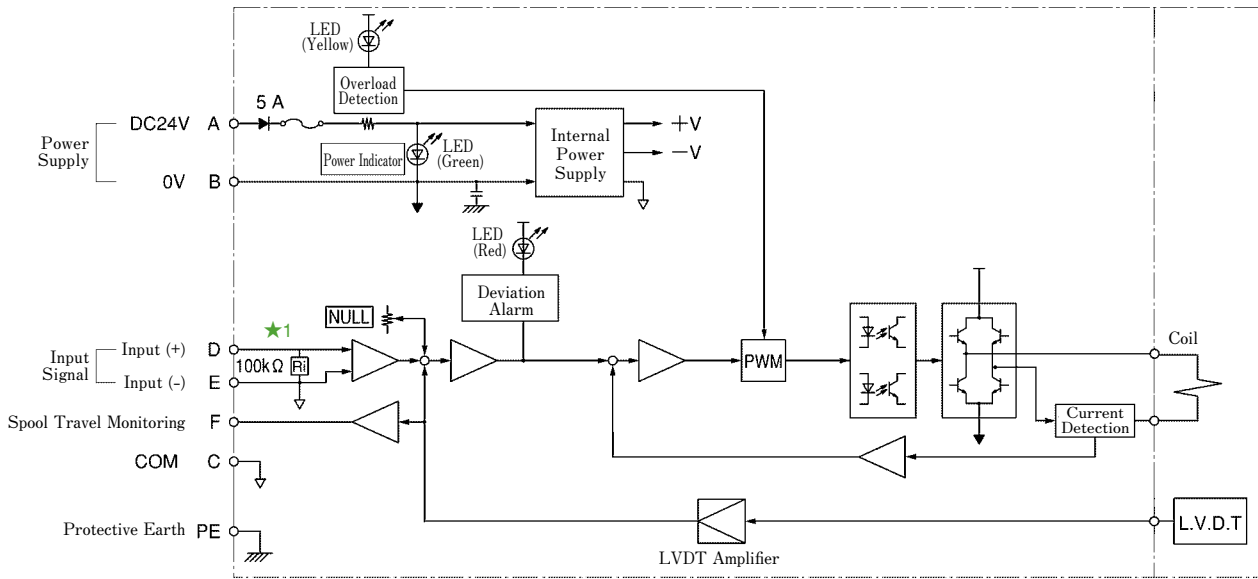

★1. The input stage for the models LSVG-*EH-*-* *-B1/C1/E1/F1 (current signal) is as follows.

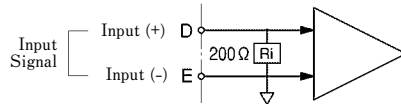

● LSVG-*EH-*-* *-A2/B2/C2/D2/E2/F2 (11 + PE Connector)

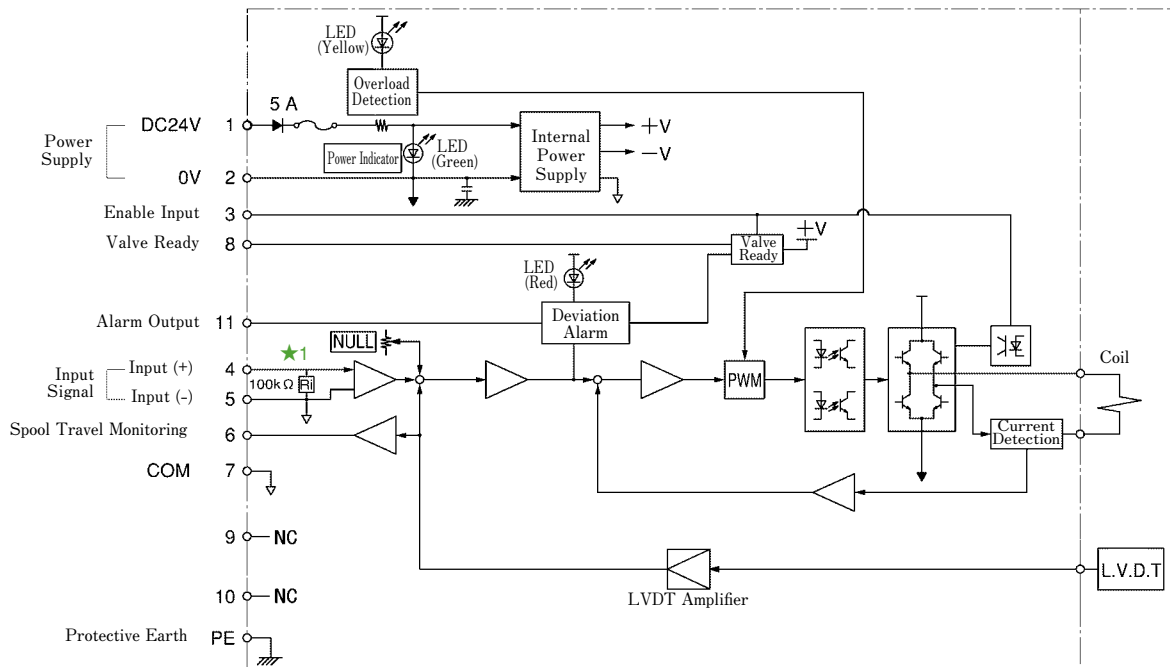

★1. The input stage for the models LSVG-*EH-*-* *-B2/C2/E2/F2 (current signal) is as follows.

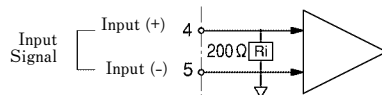

LSVG-01EH

Mounting Surface: Conforming to ISO 4401-03-02-0-94

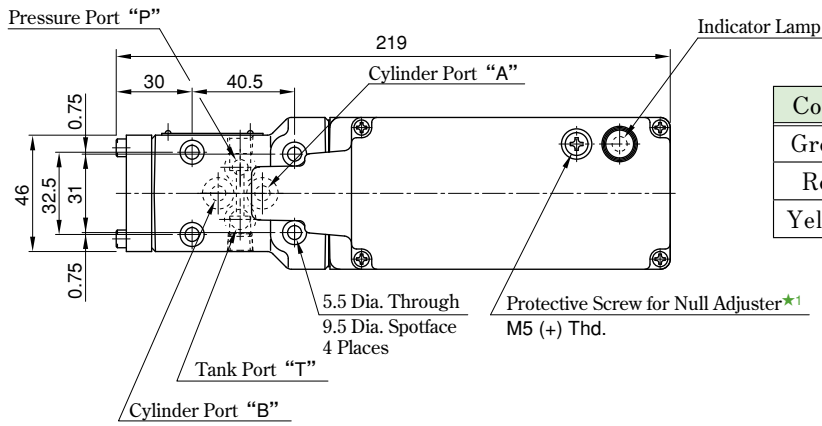

Color	Indicator Lamp
Green	Power Supply
Red	Deviation Alarm
Yellow	Overload

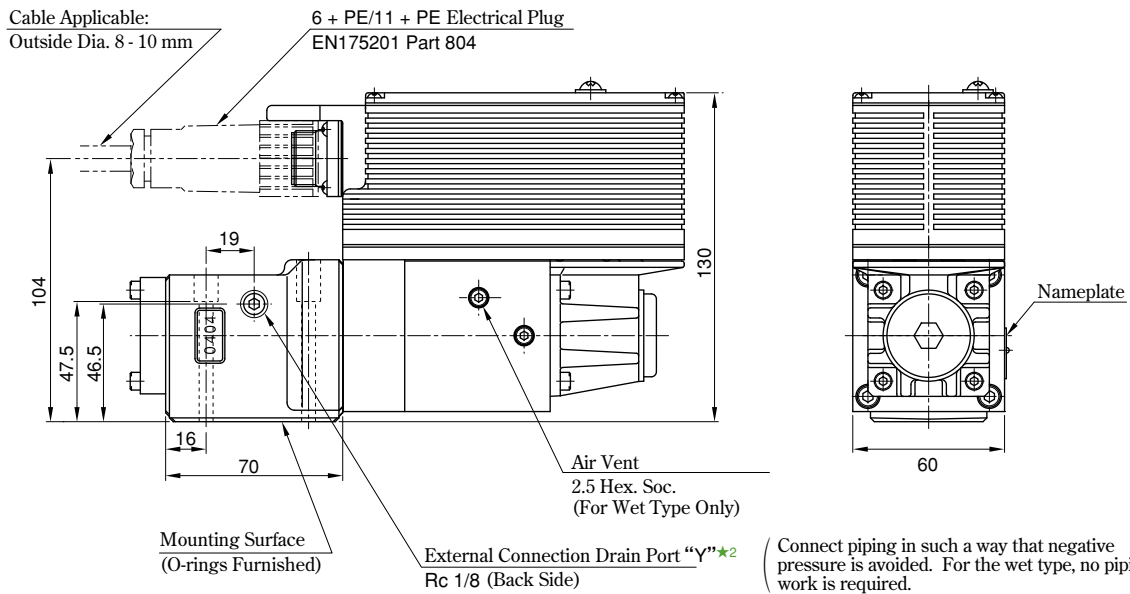

(Connect piping in such a way that negative pressure is avoided. For the wet type, no piping work is required.)

- ★1. To adjust the null, remove the protective screw and turn the null trimmer. After adjustment, be sure to attach the protective screw.
- ★2. For the dry type, the external connection drain port "Y" on the tank port side is usually plugged. To use the port on the tank port side, remove the hexagon socket head plug (5 Hex.) from the drain port on the tank port side and plug the port on the pressure port side.

● O-rings for the Ports

AS568-012 (NBR, Hs90): 4 pieces

O-rings made of fluorinated rubber are required to use phosphate ester type fluids.

● Dimensions of Mounting Surface

Prepare a mounting surface shown below. Basically, the dimensions of the mounting surface conform to the ISO standard.

The mounting surface should have a good machined finish.

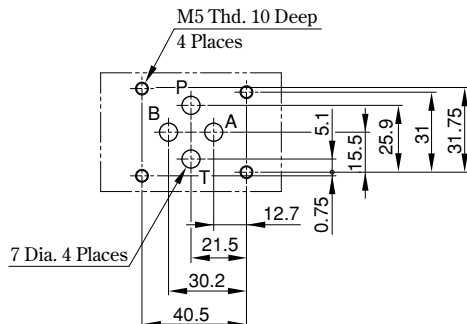

LSVG-03EH

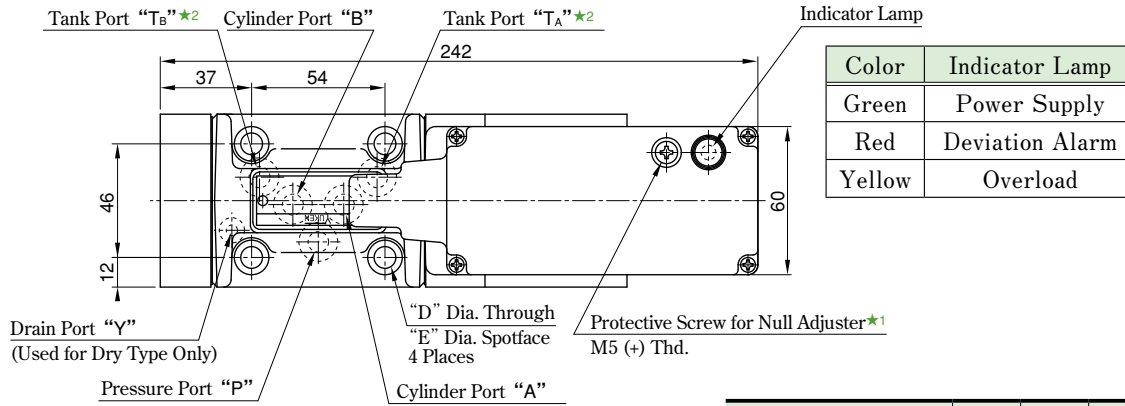

Model Number	D	E	F
LSVG-03EH- *-10	8.3	14	53
LSVG-03EH- *-1006	7	11	51

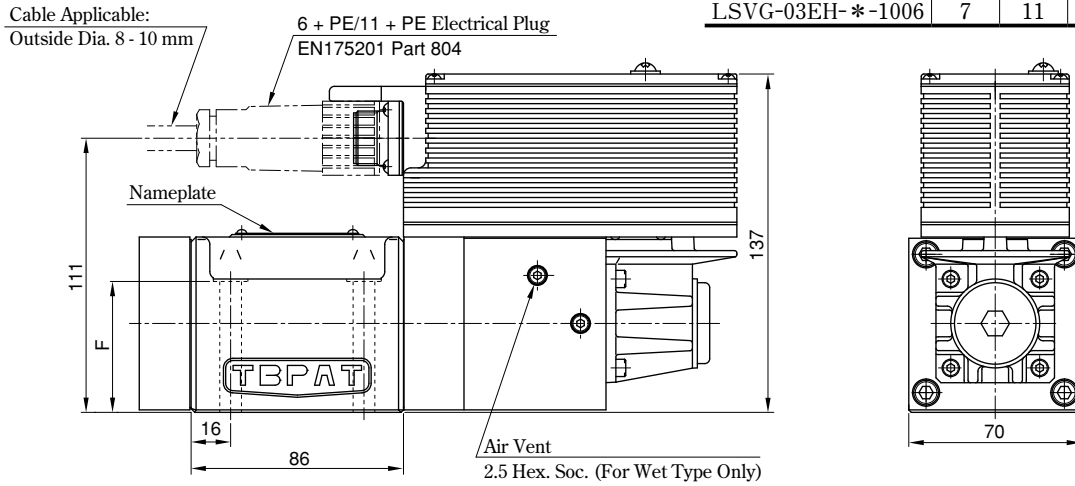

★1. To adjust the null, remove the protective screw and turn the null trimmer. After adjustment, be sure to attach the protective screw.

● O-rings for the Ports

Port	O-ring Size	Qty.
P, A, B, T	AS568-014 (NBR, Hs90)	5
Y	JIS B2401-1B-P7	1

O-rings made of fluorinated rubber are required to use phosphate ester type fluids.

● Dimensions of Mounting Surface

Prepare a mounting surface shown on the right. Basically, the dimensions of the mounting surface conform to the ISO standard, but the specifications for the valve mounting screws and the drain port "Y" (for the dry type) are different as follows.

	ISO 4401-05-04-0-94	Mounting Surface for LSVG-03EH- *-10	Mounting Surface for LSVG-03EH- *-1006
Valve Mounting Screw	M6	M8	M6
Drain Port "Y" (For Dry Type)	Without "Y" Port	With "Y" Port	With "Y" Port

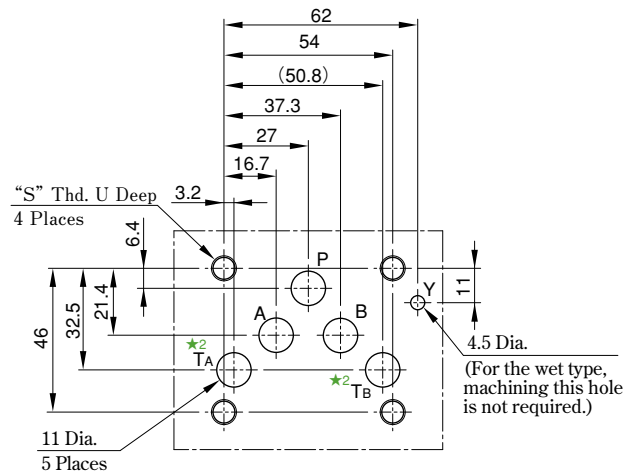

★2. There are two tank ports "T_A" and "T_B"; however, "T_A" may be used alone.

Model Number	S	U
LSVG-03EH- *-10	M8	17
LSVG-03EH- *-1006	M6	13

Characteristics of LSVG-01EH-4/10/20 (Fluid Viscosity: 30 mm²/s)

No-Load Flow Characteristics

<Conditions>

● Valve Pressure Difference : 7 MPa

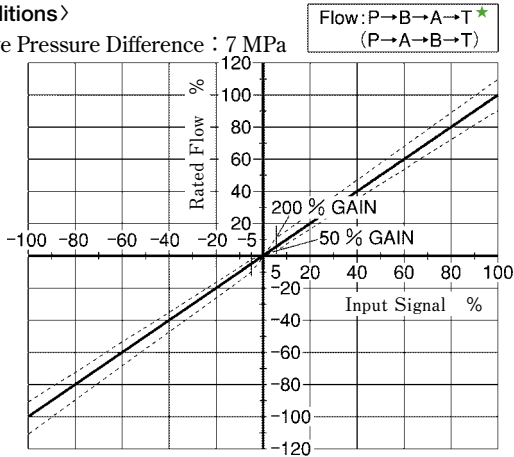

Flow: P→A→B→T★
(P→B→A→T)

★ The flow outside of parentheses is achieved when the input signal type "A", "B", or "C" is selected. The flow in parentheses is achieved when "D", "E", or "F" is selected.

Load Flow Characteristics

<Conditions> ● Input Signal : 100 %

Note) Tolerance for Load Flow : ±10 %

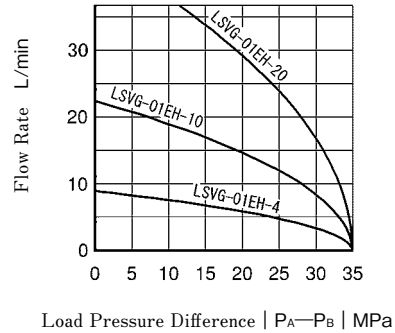

Step Response

<Conditions> ● Input Amplitude : 0 ⇔ 100 % ● Supply Pressure : 14 MPa

● LSVG-01EH-4/10/20-**-10 (Dry Type)

● LSVG-01EH-4/10/20-W**-10 (Wet Type)

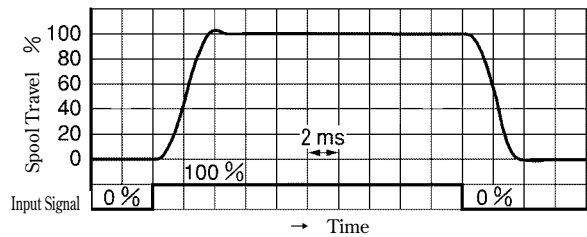
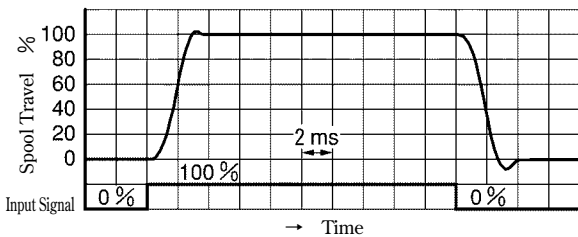

Frequency Response

<Conditions> ● Hydraulic Circuit: Port A/B Closed ● Supply Pressure : 14 MPa

● LSVG-01EH-4/10/20-**-10 (Dry Type)

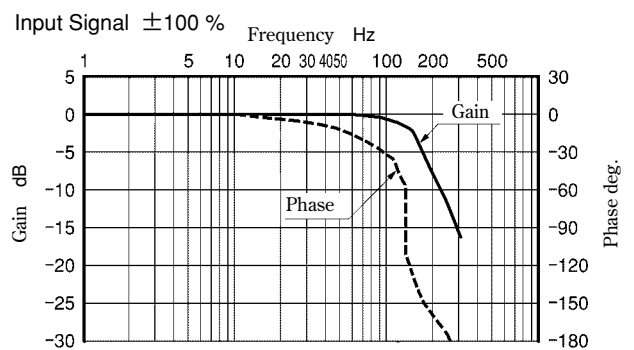
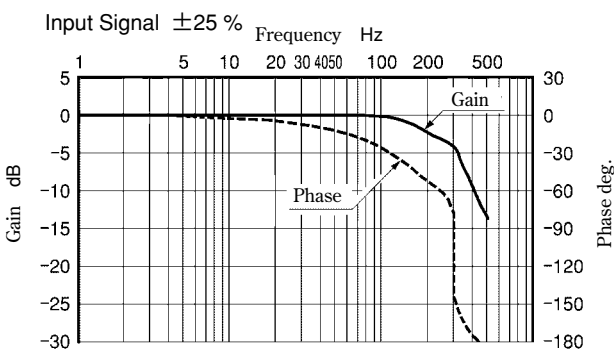

● LSVG-01EH-4/10/20-W**-10 (Wet Type)

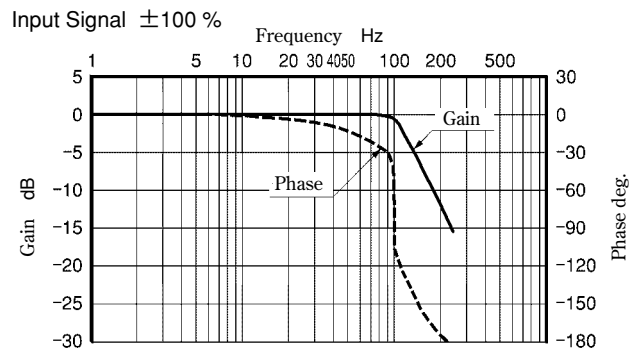
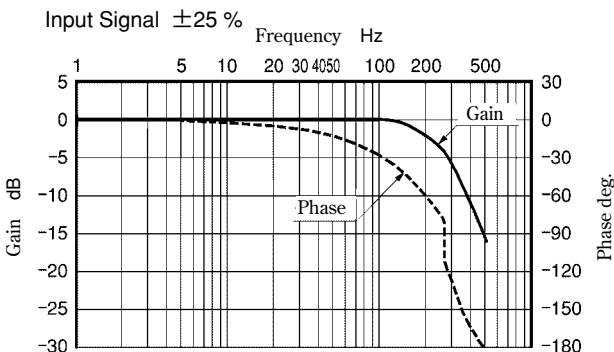

Characteristics of LSVG-03EH-40/60 (Fluid Viscosity: 30 mm²/s)

No-Load Flow Characteristics

<Conditions>

● Valve Pressure Difference : 7 MPa

Flow: P→B→A→T ★
(P→A→B→T)

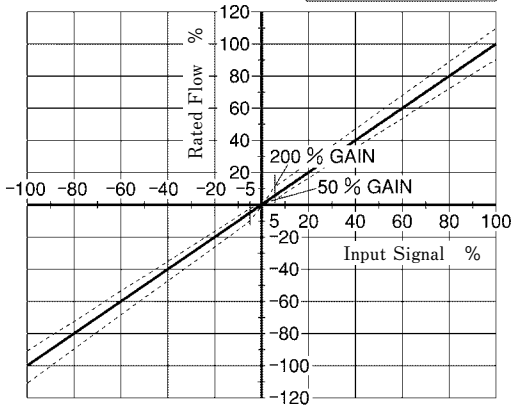

Flow: P→A→B→T ★
(P→B→A→T)

★ The flow outside of parentheses is achieved when the input signal type "A", "B", or "C" is selected. The flow in parentheses is achieved when "D", "E", or "F" is selected.

Load Flow Characteristics

<Conditions> ● Input Signal : 100 %

Note) Tolerance for Load Flow : ±10 %

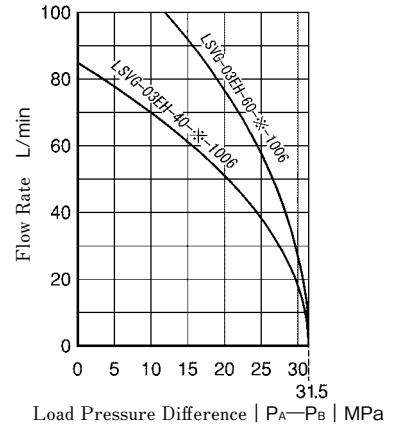
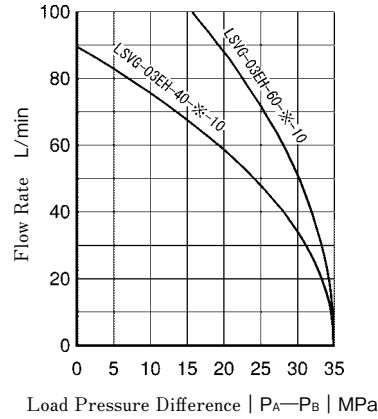

Step Response

<Conditions> ● Input Amplitude : 0 ⇔ 100 % ● Supply Pressure : 14 MPa

● LSVG-03EH-40-*-*-10 (Dry Type)

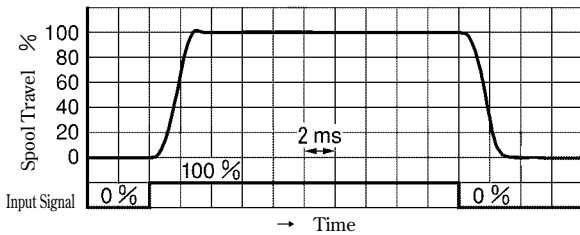

● LSVG-03EH-40-W-*-*-10 (Wet Type)

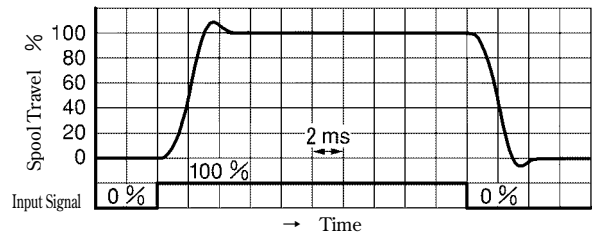

● LSVG-03EH-60-*-*-10 (Dry Type)

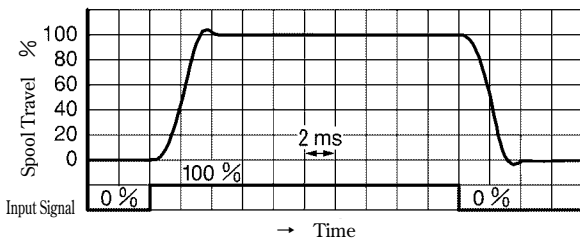

● LSVG-03EH-60-W-*-*-10 (Wet Type)

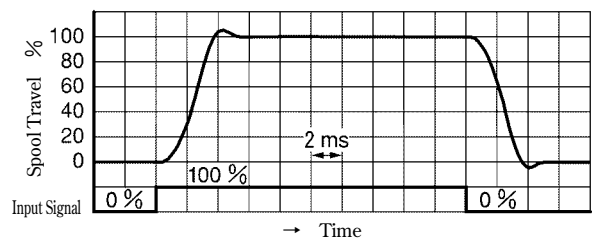

Frequency Response

<Conditions> ● Hydraulic Circuit: Port A/B Closed ● Supply Pressure : 14 MPa

● LSVG-03EH-40-**-**-10 (Dry Type)

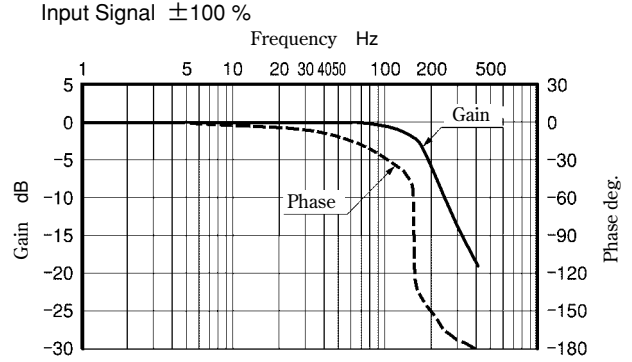
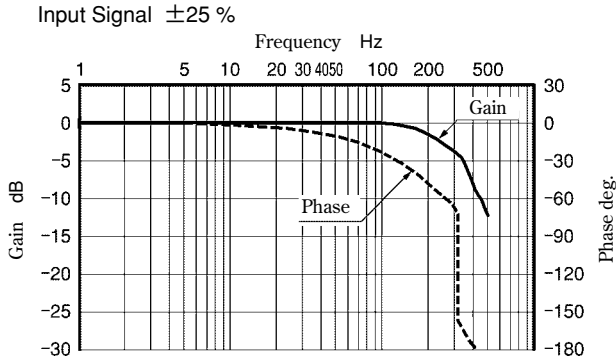

● LSVG-03EH-40-W**-**-10 (Wet Type)

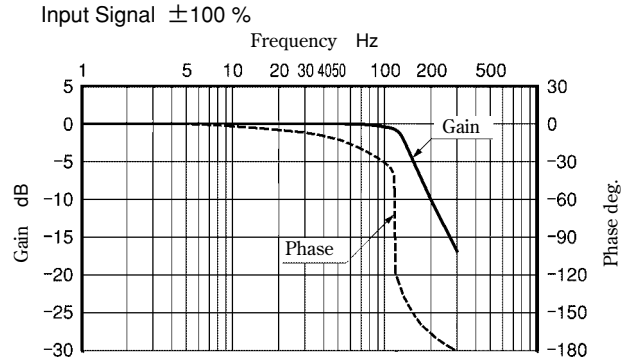
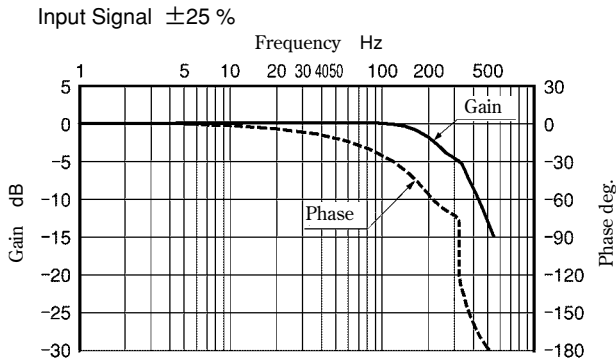

● LSVG-03EH-60-**-**-10 (Dry Type)

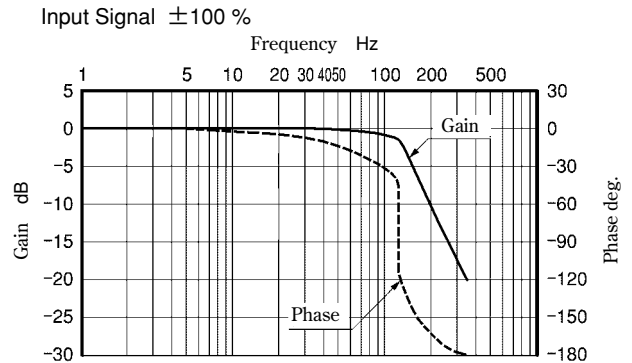
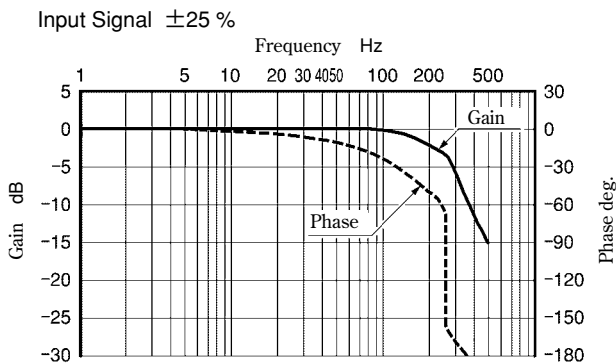

● LSVG-03EH-60-W**-**-10 (Wet Type)

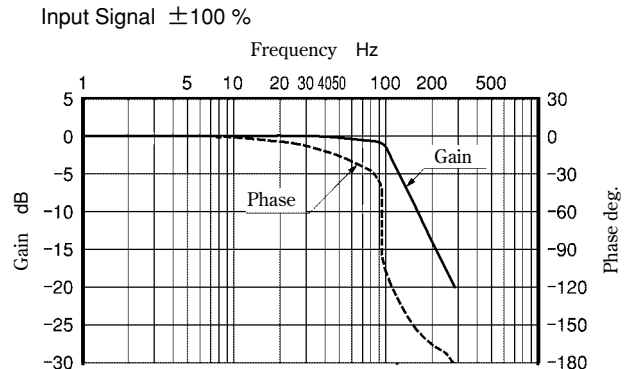
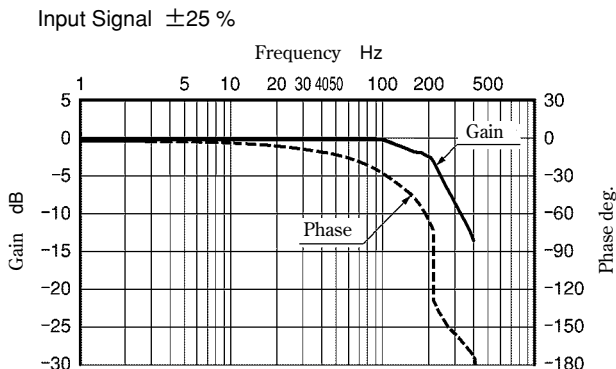

OBE(On-Board Electronic) Type Linear Servo Valves (Std. Type)

On-board electronics (OBE) type linear servo valves have been developed based on two stage type high speed linear servo valves, but with a focus on downsizing the pilot valve. The integration of the exclusive amplifier and the linear servo valve in a compact package provides “high accuracy, easiness to use, and great usability”.

- High accuracy

As is the case with the high speed linear servo valves, all of the OBE type linear servo valves have a low hysteresis of 0.1 % or less, realizing high accuracy. These valves allow the main unit to operate with much higher repeatability.

- High response characteristics

Compared to other equivalent models, these valves provide higher levels of step and frequency responses, which are typically used as measures of response characteristics; the step response is 7 ms (0 <=> 100 %)★, and the frequency response is 125 Hz/-3 dB (± 25 % amplitude)★. (★ : Representative values for LSVHG-03EH)

- Easiness to use

These valves can offer high accuracy for hydraulic control systems just with 24 V DC power supply and command signal input.

Six types of input signals in three input voltage/current ranges are available: 0 - ±10 V, 0 - ±10 mA, and 4 - 20 mA.

- Great usability

The small amplifier in the valves has a fault indicator lamp. This lamp indicates an error when valve failure causes any deviation between the spool position commanded by the signal and the actual spool position. It facilitates you to immediately troubleshoot the failure of the valves, if any.

- Two types of pilot valves available

There are two types of pilot valves available: a dry type good in response characteristics and a wet type that eliminates the drain (DR) port to improve usability. They can be selected according to users' purposes.

- Excellent contamination resistance

As is the case with the high speed linear servo valves, the OBE type linear servo valves have a simple pilot valve structure, exhibiting excellent contamination resistance. The permissible level of fluid contamination for these valves is up to NAS 1638 class 10.

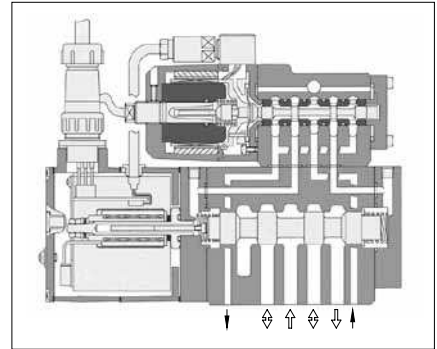
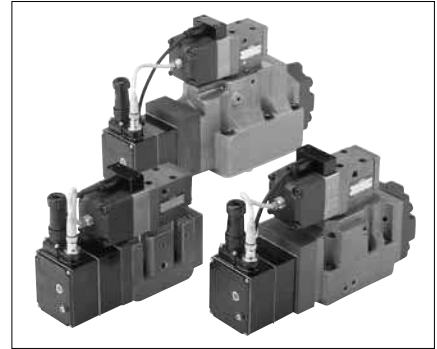

Graphic Symbols

- Spool Types “2”, “2P”, and “2L”

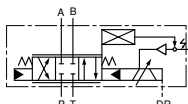

Int. Pilot - Int. Drain

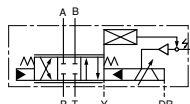

Int. Pilot - Ext. Drain

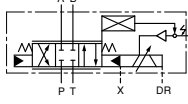

Ext. Pilot - Int. Drain

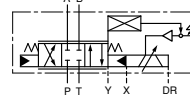

Ext. Pilot - Ext. Drain

- Spool Type “40”

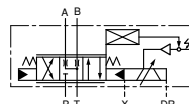

- Spool Type “4J”

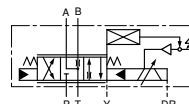

The symbols above indicate the external pilot/internal drain type. The internal pilot/internal drain type is the same as that for the spool types “2”, “2P”, and “2L”.

Input Signal/Spool Travel Monitoring “D”/“E”/“F”

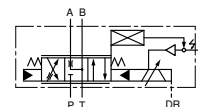

The pilot and drain types are the same as those for the input signal/spool travel monitoring “A”/“B”/“C”.

- Detailed Graphic Symbols (With Fail-safe Solenoid Operated Valve)

LSVHG-03/04EH-**-**EA/*EB/*EC

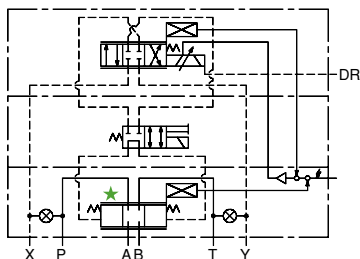

LSVHG-06/10EH-**-**EA/*EB/*EC

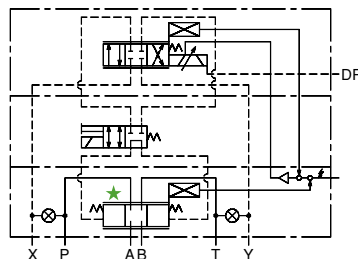

⊗ : Plugs for selecting the pilot and drain types

★ : Depending on the spool type.

(Same as the graphic symbols shown above)

Model Number Designation

F-	LSVHG	-06	EH	-900	-2P	-E	T	-W	A	-A	1	-20																										
Fluid Type	Series Number	Valve Size	Amp. Type	Rated Flow @ΔP = 7 MPa	Spool Type	Pilot Type	Drain Type	DR Port and Permissible Back Pres.	Fail-safe Function	Input Signal/Spool Travel Monitoring	Connector Type	Design Number																										
F: Special Seals for Phosphate Ester Type Fluid (Omit if not required)	LSVHG: Two Stage Type Linear Servo Valves	03	EH: OBE Type	230: 230 L/min	2L	None: Internal Pilot	None: External Drain	None: With DR Port (Permissible Back Pres.: 0.05 MPa) (Dry Type Pilot Valve)	None: P→B→A→T Position Valve Opening: Full	A: P→A→B→T Position Valve Opening: Full	A: Voltage Signal ±10 V (P→B→A→T Flow with Input Signal (+))	1: PE Pole																										
				270: 270 L/min	2, 40, 2P								E: External Pilot	T: Internal Drain	W:*2 Without DR Port (Wet Type Pilot Valve)	None: P→B→A→T Position Valve Opening: Full	A: P→A→B→T Position Valve Opening: Full	B: Current Signal 4 - 20 mA (P→B→A→T Flow with Current Signal 12 - 20 mA)	2:*3 PE Pole																			
				210:*4 210 L/min	4J:Open Centre A, B & T															EC: With Solenoid Operated Valve P→A→B→T Position Valve Opening: 10%	D: Voltage Signal ±10 V (P→A→B→T Flow with Input Signal (+))	11+ PE Pole																
		750: 750 L/min		2L: 2% Overlap (Linear Flow Gain)	EC: With Solenoid Operated Valve P→B→A→T Position Valve Opening: 10%																		E: Current Signal 4 - 20 mA (P→A→B→T Flow with Current Signal 12 - 20 mA)															
		580:*4 580 L/min		4J:Open Centre A, B & T																				None: P→B→A→T Position Valve Opening: Full	A: P→A→B→T Position Valve Opening: Full	F: Current Signal ±10 mA (P→A→B→T Flow with Input Signal (+))												
		900: 900 L/min		2, 40, 2P																							None: P→B→A→T Position Valve Opening: Full	A: P→A→B→T Position Valve Opening: Full										
		1300: 1300 L/min		2L: 2% Overlap (Linear Flow Gain)																									None: P→B→A→T Position Valve Opening: Full	A: P→A→B→T Position Valve Opening: Full								
		820:*4 820 L/min		4J:Open Centre A, B & T																											None: P→B→A→T Position Valve Opening: Full	A: P→A→B→T Position Valve Opening: Full						
		1300: 1300 L/min		2L: 2% Overlap (Linear Flow Gain)																													None: P→B→A→T Position Valve Opening: Full	A: P→A→B→T Position Valve Opening: Full				
		3800: 3800 L/min		2, 40, 2P																															None: P→B→A→T Position Valve Opening: Full	A: P→A→B→T Position Valve Opening: Full		
				2L: 2% Overlap (Linear Flow Gain)																																	None: P→B→A→T Position Valve Opening: Full	A: P→A→B→T Position Valve Opening: Full
		None: P→B→A→T Position Valve Opening: Full	A: P→A→B→T Position Valve Opening: Full																																			

- ★ 1. The available combinations of the spool type, fail-safe function, and input signal/spool travel monitoring are limited. For details, see the chart on the right.
- ★ 2. The valves with the model number “W” (without DR port) cannot use water-glycol fluids.
- ★ 3. For the valves with the fail-safe function “EC”, select “2” only for the connector type.
- ★ 4. For the spool type “4J”, the rated flow is a value obtained with +100% input and P → A flow (input signal/spool travel monitoring “A”, “B”, and “C”) or P → B flow (“D”, “E”, and “F”).
- ★ 5. For the spool function in the neutral position, see the chart below.

Spool Type	Fail-safe Function	Input Signal/Spool Travel Monitoring
2	With Solenoid Operated Valve: EC	All (A, B, C, D, E, F)
40	Without Solenoid Operated Valve: None/A	
2L	With Solenoid Operated Valve: EA/EB	
2P	Without Solenoid Operated Valve: None/A	
4J	With Solenoid Operated Valve: EC	D, E, F
	Without Solenoid Operated Valve: None	A, B, C
	Without Solenoid Operated Valve: A	

Spool Function in Neutral Position

Spool Type	Function
2, 2P, 2L	
40	
4J	

Fail-safe Function of the Valves

With reference to the information given below, select the option for the fail-safe function according to the use of applications. The valves have a fail-safe function, but a separate safety circuit should be provided if the hydraulic actuator must be reliably held or stopped to ensure safety in the event of electric failure (power failure, power cable disconnection, etc.) or upon startup.

1) Electric System: OFF and Hydraulic System: ON (Power Failure/Power Cable Disconnection)

No.	Model Number	Fail-safe Function*
1	(F-)LSVHG-* *EH-* -2/2P/2L (-E) (T) (-W)	P→B→A→T Position Valve Opening: Full
2	(F-)LSVHG-* *EH-* -2/2P/2L (-E) (T) (-W) A	P→A→B→T Position Valve Opening: Full
3	(F-)LSVHG-* *EH-* -4J (-E) (T) (-W)	P→B→A→T Position Valve Opening: Full
4	(F-)LSVHG-* *EH-* -4J (-E) (T) (-W) A	P→A→B→T Position Valve Opening: Full
5	(F-)LSVHG-* *EH-* -2/2P/2L (-E) (T) (-W) EA (With Fail-safe Solenoid Operated Valve)	P→A→B→T Position Valve Opening: 10%
6	(F-)LSVHG-* *EH-* -2/2P/2L (-E) (T) (-W) EB (With Fail-safe Solenoid Operated Valve)	P→B→A→T Position Valve Opening: 10%
7	(F-)LSVHG-* *EH-* -4J (-E) (T) (-W) EC-A*/B*/C* (With Fail-safe Solenoid Operated Valve)	A, B, T Connection (Neutral)
8	(F-)LSVHG-* *EH-* -4J (-E) (T) (-W) EC-D*/E*/F* (With Fail-safe Solenoid Operated Valve)	A, B, T Connection (Neutral)

★The fail-safe activation time depends on the electric and hydraulic conditions.

2) Electric System: OFF and Hydraulic System: OFF (Startup)

For Models No. 1 and 2 in the table above, the fail-safe function holds the spool in the neutral position. For Models No. 5 and 6, the function is the same as that for “Electric System: OFF and Hydraulic System: ON”. For Models No. 3, 4, 7, and 8, the function is based on A, B, T connection (neutral).

Specifications

LSVHG- *EH- * -2/40/2P/2L

The values in parentheses in the specification table below are applicable to the models “LSVHG- *EH- *- *- *-W *-” (without DR port).

Description			Model Numbers		LSVHG-03EH-230-*	LSVHG-03EH-270-*	LSVHG-04EH-750-*	LSVHG-06EH-900-*	LSVHG-06EH-1300-*	LSVHG-10EH-3800-*												
Spool Type			2 L		2	40	2P	2	40	2P	2 L	2	40	2P	2 L	2	40	2P	2 L			
Rated Flow at $\Delta P = 7$ MPa (4-Way Valve) L/min			230		270		750		900		1300		3800									
Rated Flow at $\Delta P' = 0.5$ MPa (per Land) L/min			87		102		283		340		490		1440									
Max. Operating Pressure MPa			31.5		35		35		31.5		35		28									
Proof Pres. at Return Port ⁽¹⁾	External Drain	T Port MPa	21 ⁽⁵⁾		31.5		35		25		28											
		Y Port MPa	21 (7) ⁽⁵⁾		21 (7)		21 (7)		21 (7)		21 (7)											
	Internal Drain	T & Y Port MPa	21 (7) ⁽⁵⁾		21 (7)		21 (7)		21 (7)		21 (7)											
DR Port Permissible Back Pressure ⁽²⁾ MPa			0.05 (The valves with the model number “W” have no DR port.)																			
Pilot Pressure ⁽³⁾ MPa			1.5 - 21																			
Pilot Flow Rate ⁽⁴⁾ L/min			9 (8) or more		20 (17) or more		22 (19) or more		23 (19) or more		28 (24) or more											
Pilot Valve Max. Leakage	Pres.: $P_s = P_p = 14$ MPa	L/min	0.8		1.2																	
			1.6		0.5	1	5.6	0.8	1.6	6.8	2.5	0.9	1.8	7	2.5	1	2	8	2.5	3	6	10
Main Valve Max. Leakage	Max. Leakage Viscosity: 32 mm ² /s																					
Hysteresis %			0.1 or less																			
Step Response (0 <=> 100 %, Typical) ⁽⁶⁾ ms			8 (10)		7 (9)		11 (13)		11 (13)		15 (18)		18 (20)									
Frequency Response (± 25 % Amplitude, Typical) ⁽⁶⁾	Gain: -3 dB	Hz	120 (100)		125 (110)		100 (90)		100 (90)		75 (70)		60 (55)									
	Phase: -90°	Hz	110 (90)		110 (100)		90 (90)		90 (90)		70 (75)		70 (60)									
Vibration Proof ⁽⁷⁾ m/s ²			100																			
Protection			IP 65																			
Ambient Temperature °C			0 - +50																			
Spool Stroke to Stops mm			± 4		± 3.5		± 5		± 5		± 7		± 7									
Spool End Area cm ²			3		7		8		8		11.3											
Polarity			See the description about I/O signal characteristics on page 35.																			
Linear Motor Specification	Current	A	Max. 2.1																			
	Coil Resistance	Ω	9.6 [at 20 °C]																			
Approx. Mass ⁽⁸⁾ kg			8.5 [11]		14 [16]		20 [24]		20 [24]		77											
Electric Connection			6 + PE/11 + PE Connector (EN175201 Part 804)																			

Note: ⁽¹⁾ Pressure at the return port should be at actual supply pressure or less.

⁽²⁾ Back pressure at the drain port should be 0.05 MPa or less and not be a negative pressure.

⁽³⁾ Supply pressure for the pilot valve should be 1.5 - 21 MPa and should also be 60 % of actual supply pressure or more.

⁽⁴⁾ The pilot flow is calculated based on a pilot pressure of 14 MPa and the above step response.

⁽⁵⁾ To use an external pilot type valve with a supply pressure of 21 MPa or more, pressures at the T and Y ports should be 7 MPa or less.

⁽⁶⁾ This value is measured for each valve based on a pilot pressure of 14 MPa; it may vary depending on the actual circuit/operation conditions.

⁽⁷⁾ There are restrictions on the mounting position; refer to the instructions for details.

⁽⁸⁾ A value in brackets indicates the mass of each valve with a fail-safe solenoid operated valve.

⁽⁹⁾ For the effective range of the fail-safe function, see page 59.

Specifications

LSVHG- *EH- * -4J- * -A * /B * /C *

The values in parentheses in the specification table below are applicable to the models “LSVHG- *EH- * - * - * - *EH-W * -” (without DR port).

Description		Model Numbers	LSVHG-03EH-210 -4J- * -A * /B * /C *	LSVHG-04EH-580 -4J- * -A * /B * /C *	LSVHG-06EH-820 -4J- * -A * /B * /C *	LSVHG-06EH-1300 -4J- * -A * /B * /C *	
Spool Type		4J: Open Centre A, B & T P→B Flow: 10 % Overlap, A→T Flow: 50 % Underlap P→A Flow: 60 % Overlap, B→T Flow: 5 % Underlap					
Rated Flow (±10%)	ΔP = 3.5 MPa (per Land)	L/min	P→B Flow: 210 A→T Flow: 235 P→A Flow: 95 B→T Flow: 240	P→B Flow: 580 A→T Flow: 675 P→A Flow: 255 B→T Flow: 660	P→B Flow: 820 A→T Flow: 950 P→A Flow: 370 B→T Flow: 940	P→B Flow: 1300 A→T Flow: 1440 P→A Flow: 660 B→T Flow: 1375	
	ΔP = 0.5 MPa (per Land)	L/min	P→B Flow: 79 A→T Flow: 89 P→A Flow: 36 B→T Flow: 91	P→B Flow: 219 A→T Flow: 255 P→A Flow: 96 B→T Flow: 249	P→B Flow: 310 A→T Flow: 359 P→A Flow: 140 B→T Flow: 355	P→B Flow: 491 A→T Flow: 544 P→A Flow: 249 B→T Flow: 520	
Max. Operating Pressure		MPa	31.5	35	35	31.5	
Proof Pres. at Return Port ⁽¹⁾	External Drain	T Port	MPa	21	31.5	35	25
		Y Port	MPa	21 (7)			
	Internal Drain	T & Y Ports	MPa	21 (7)			
DR Port Permissible Back Pressure ⁽²⁾		MPa	0.05 or less (The valves with the model number “W” have no DR port.)				
Pilot Pressure ⁽³⁾		MPa	1.5 - 21				
Pilot Flow Rate ⁽⁴⁾		L/min	9 (8) or more	20 (17) or more	22 (19) or more	23 (19) or more	
Pilot Valve Max. Leakage	Pres.: P _s = P _p = 14 MPa Max. Leakage Viscosity: 32 mm ² /s	L/min	0.8 or less	1.2 or less	1.2 or less		
Main Valve Max. Leakage			0.7 or less	1.1 or less	1.2 or less		
Hysteresis		%	0.1 or less				
Step Response (0 <=> 100 %) P _p = 14 MPa (Typical) ⁽⁵⁾		ms	7 (9)	11 (13)	11 (13)	15 (18)	
Frequency Response (±25 % Amplitude) P _p = 14 MPa (Typical) ⁽⁵⁾		Hz	Gain = -3 dB: 125 (110) Phase = -90° : 110 (100)	Gain = -3 dB: 100 (90) Phase = -90° : 90 (90)	Gain = -3 dB: 100 (90) Phase = -90° : 90 (90)	Gain = -3 dB: 75 (70) Phase = -90° : 70 (75)	
Vibration Proof		m/s ²	100				
Protection			IP 65				
Ambient Temperature		°C	0 - +50				
Spool Stroke to Stops		mm	±3.5	±5	±5	±7	
Spool End Area		cm ²	3	7	8	8	
Polarity			See the description about I/O signal characteristics on page 35.				
Linear Motor Specification	Current	A	Max. 2.1				
	Coil Resistance	Ω	9.6 [at 20 °C]				
Approx. Mass ⁽⁶⁾		kg	8.5 [11]	14 [16]	20 [24]		
Electric Connection			6 + PE/11 + PE Connector 【EN175201 Part 804】				

Note: (1) Pressure at the return port should be at actual supply pressure or less (to use an external pilot type valve with the size “03” at 21 MPa or more, pressures at the T and Y ports should be 7 MPa or less).

(2) Back pressure at the drain port should be 0.05 MPa or less and not be a negative pressure.

(3) Supply pressure for the pilot valve should be 1.5 - 21 MPa and should also be 60 % of actual supply pressure or more.

(4) The pilot flow is calculated based on a pilot pressure of 14 MPa and the above step response.

(5) This value is measured for each valve based on a pilot pressure of 14 MPa; it may vary depending on the actual circuit/operation conditions.

(6) A value in brackets indicates the mass of each valve with a fail-safe solenoid operated valve.

(7) For the effective range of the fail-safe function, see page 59.

Specifications

LSVHG-*EH-*-4J-*-D*/E*/F*

The values in parentheses in the specification table below are applicable to the models “LSVHG-*EH-*-**EH-W*-*” (without DR port).

Model Numbers		LSVHG-03EH-210 -4J-*-D*/E*/F*	LSVHG-04EH-580 -4J-*-D*/E*/F*	LSVHG-06EH-820 -4J-*-D*/E*/F*	LSVHG-06EH-1300 -4J-*-D*/E*/F*		
Description							
Spool Type		4J: Open Centre A, B & T P→A Flow: 10 % Overlap, B→T Flow: 50 % Underlap P→B Flow: 60 % Overlap, A→T Flow: 5 % Underlap					
Rated Flow (±10%)	ΔP = 3.5 MPa (per Land)	L/min	P→A Flow: 210 B→T Flow: 235 P→B Flow: 95 A→T Flow: 240	P→A Flow: 580 B→T Flow: 675 P→B Flow: 255 A→T Flow: 660	P→A Flow: 820 B→T Flow: 950 P→B Flow: 370 A→T Flow: 940	P→A Flow: 1300 B→T Flow: 1440 P→B Flow: 660 A→T Flow: 1375	
	ΔP = 0.5 MPa (per Land)	L/min	P→A Flow: 79 B→T Flow: 89 P→B Flow: 36 A→T Flow: 91	P→A Flow: 219 B→T Flow: 255 P→B Flow: 96 A→T Flow: 249	P→A Flow: 310 B→T Flow: 359 P→B Flow: 140 A→T Flow: 355	P→A Flow: 491 B→T Flow: 544 P→B Flow: 249 A→T Flow: 520	
Max. Operating Pressure		MPa	31.5	35	35	31.5	
Proof Pres. at Return Port (1)	External Drain	T Port	MPa	21	31.5	35	25
		Y Port	MPa	21 (7)			
	Internal Drain	T & Y Ports	MPa	21 (7)			
DR Port Permissible Back Pressure (2)		MPa	0.05 or less (The valves with the model number “W” have no DR port.)				
Pilot Pressure (3)		MPa	1.5 - 21				
Pilot Flow Rate (4)		L/min	9 (8) or more	20 (17) or more	22 (19) or more	23 (19) or more	
Pilot Valve Max. Leakage	Pres.: PS = PP = 14 MPa Max. Leakage Viscosity: 32 mm ² /s	L/min	0.8 or less	1.2 or less	1.2 or less		
			0.7 or less	1.1 or less	1.2 or less		
Hysteresis		%	0.1 or less				
Step Response (0 <=> 100 %) Pp = 14 MPa (Typical) (5)		ms	7 (9)	11 (13)	11 (13)	15 (18)	
Frequency Response (± 25 % Amplitude) Pp = 14 MPa (Typical) (5)		Hz	Gain = -3 dB: 125 (110) Phase = -90° : 110 (100)	Gain = -3 dB: 100 (90) Phase = -90° : 90 (90)	Gain = -3 dB: 100 (90) Phase = -90° : 90 (90)	Gain = -3 dB: 75 (70) Phase = -90° : 70 (75)	
Vibration Proof		m/s ²	100				
Protection			IP 65				
Ambient Temperature		°C	0 - +50				
Spool Stroke to Stops		mm	±3.5	±5	±5	±7	
Spool End Area		cm ²	3	7	8	8	
Polarity			See the description about I/O signal characteristics on page 35.				
Linear Motor Specification	Current	A	Max. 2.1				
	Coil Resistance	Ω	9.6 [at 20 °C]				
Approx. Mass (6)		kg	8.5 [11]	14 [16]	20 [24]		
Electric Connection			6 + PE/11 + PE Connector [EN175201 Part 804]				

- Note: (1) Pressure at the return port should be at actual supply pressure or less (to use an external pilot type valve with the size “03” at 21 MPa or more, pressures at the T and Y ports should be 7 MPa or less).
 (2) Back pressure at the drain port should be 0.05 MPa or less and not be a negative pressure.
 (3) Supply pressure for the pilot valve should be 1.5 - 21 MPa and should also be 60 % of actual supply pressure or more.
 (4) The pilot flow is calculated based on a pilot pressure of 14 MPa and the above step response.
 (5) This value is measured for each valve based on a pilot pressure of 14 MPa; it may vary depending on the actual circuit/operation conditions.
 (6) A value in brackets indicates the mass of each valve with a fail-safe solenoid operated valve.
 (7) For the effective range of the fail-safe function, see page 59.

Attachment

Mounting Bolt

Model Number	Mounting Bolt	Qty.	Bolt Tightening Torque
LSVHG-03EH	Hex. Soc. Head Cap Screw : M6×35L	4	12.9 - 15.9 Nm
LSVHG-04EH	Hex. Soc. Head Cap Screw : M6×55L	2	12.9 - 15.9 Nm
	Hex. Soc. Head Cap Screw : M10×60L	4	60.6 - 74.1 Nm
LSVHG-06EH	Hex. Soc. Head Cap Screw : M12×85L	6	104 - 127 Nm
LSVHG-10EH	Hex. Soc. Head Cap Screw : M20×90L	6	493 - 603 Nm

Connector

Model Number	Connector	Qty.	Remarks
LSVHG-*EH -*-*1	6 + PE Electrical Plug	1	Compatible with EN 175201 PART 804
LSVHG-*EH -*-*2	11 + PE Electrical Plug	1	

Electrical Specifications

6 + PE Connector

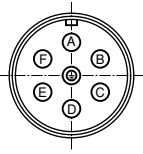

Pin		Valve Model		
		LSVHG- *EH- * -A1 LSVHG- *EH- * -D1	LSVHG- *EH- * -B1 LSVHG- *EH- * -E1	LSVHG- *EH- * -C1 LSVHG- *EH- * -F1
Pin A	Power Supply	24 V DC (21.6 - 26.4 V DC Included Ripple), 50 VA or more		
Pin B		0 V		
Pin C	Signal Common	COM (0 V)		
Pin D	Input (+) (Differential) ^{★1}	0 - ±10 V	4 - 20 mA	0 - ±10 mA
Pin E	Input (-) (Differential) ^{★1}	R _i = 100 kΩ	R _i = 200 Ω	R _i = 200 Ω
Pin F	Spool Travel Monitoring	0 - ±10 V R _L ≥ 10 kΩ	4 - 20 mA R _L = 100 - 500 Ω ^{★2}	0 - ±10 mA R _L = 100 - 500 Ω ^{★2}
Pin	Protective Earth	—		

11 + PE Connector

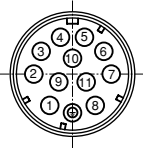

Pin		Valve Model		
		LSVHG- *EH- * -A2 LSVHG- *EH- * -D2	LSVHG- *EH- * -B2 LSVHG- *EH- * -E2	LSVHG- *EH- * -C2 LSVHG- *EH- * -F2
Pin 1	Power Supply	24 V DC (21.6 - 26.4 V DC Included Ripple), 50 VA or more		
Pin 2		0 V		
Pin 3	Enable (Servo ON) Input	Input Current = 3 - 5 mA at 4.8 - 28 V DC		
Pin 4	Input (+) (Differential) ^{★1}	0 - ±10 V	4 - 20 mA	0 - ±10 mA
Pin 5	Input (-) (Differential) ^{★1}	R _i = 100 kΩ	R _i = 200 Ω	R _i = 200 Ω
Pin 6	Spool Travel Monitoring	0 - ±10 V R _L ≥ 10 kΩ	4 - 20 mA R _L = 100 - 500 Ω ^{★2}	0 - ±10 mA R _L = 100 - 500 Ω ^{★2}
Pin 7	Signal Common	COM (0 V)		
Pin 8	Valve Ready Output	Open Collector Output Voltage: Max. 30 V, Current: Max. 20 mA		
Pin 9 ^{★3}	Power Supply (For Solenoid Operated Valve)	24 V DC (21.6 - 26.4 V DC Included Ripple), 14 VA (Holding Current: 0.6 A)		
Pin 10 ^{★3}		0 V		
Pin 11	Alarm Output	Open Collector Output Voltage: Max. 30 V, Current: Max. 20 mA		
Pin	Protective Earth	—		

★1. Differential input signals can be used only for the valves with the voltage signal specifications of ±10 V (LSVHG- *EH-A*/D*).

★2. The recommended load resistance is 200 Ω.

★3. Pins 9 and 10 are used only for the valves with a fail-safe solenoid operated valve. In this case, use a separate power source for the solenoid operated valve from the power source for the amplifier (Pins 1 and 2).

I/O Signal Characteristics

· LSVHG- *EH- * -A*/B*/C*

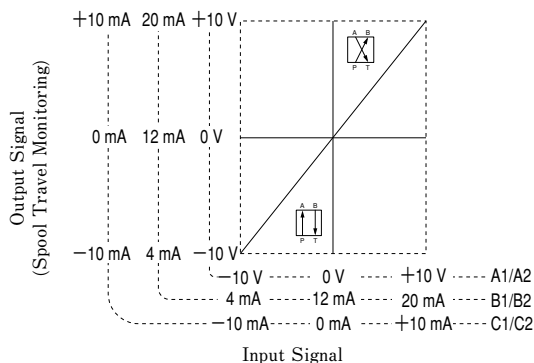

· LSVHG- *EH- * -D*/E*/F*

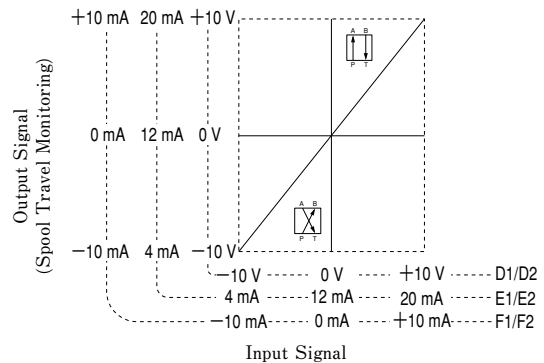

Block Diagram

● LSVHG- *EH- * - * -A1/D1 (6 + PE Connector)

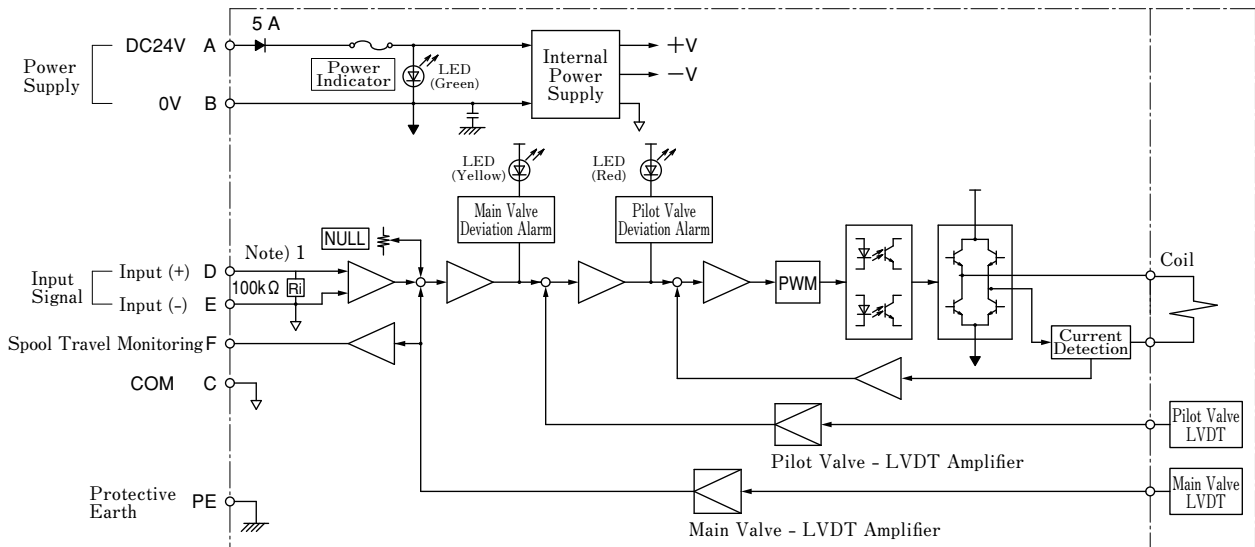

Note) 1. The input stage for the models LSVHS- *EH- * - * -B1/C1/E1/F1 (current signal) is as follows.

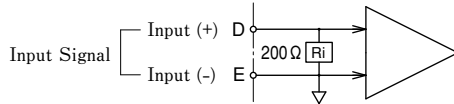

● LSVHG- *EH- * - * -A2/D2 (11 + PE Connector)

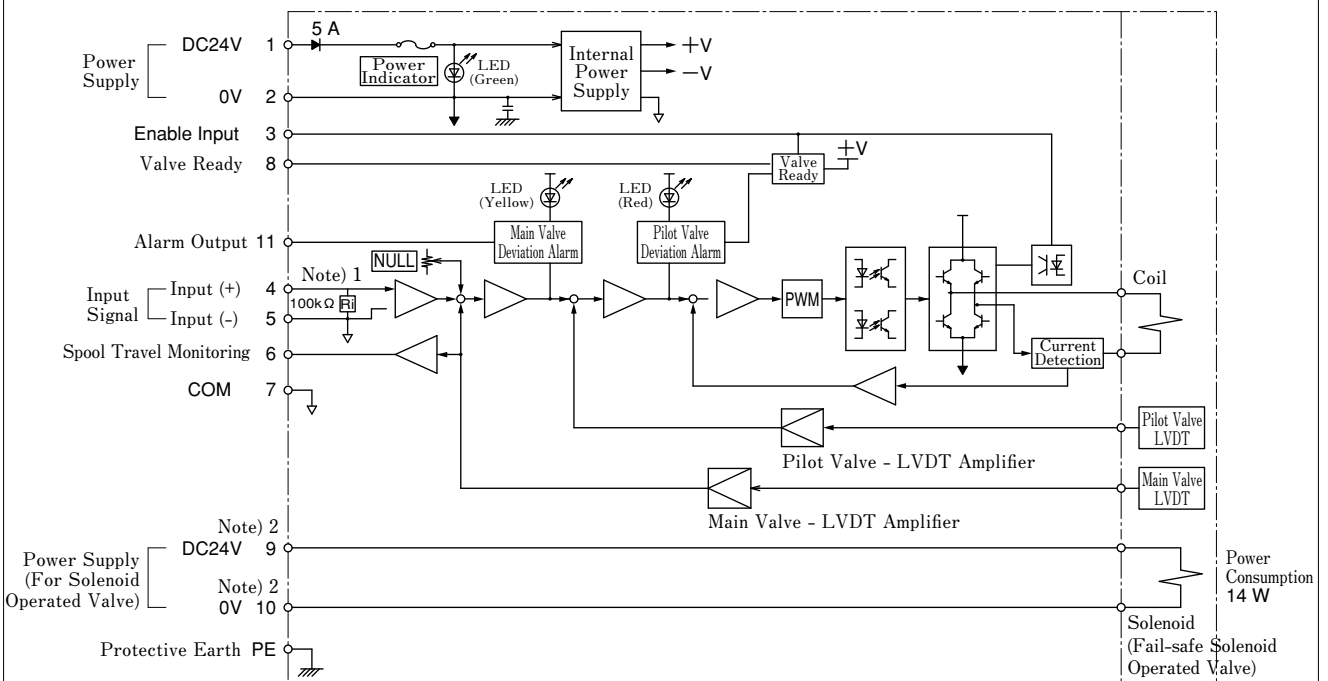

Note) 1. The input stage for the models LSVHG- *EH- * - * -B2/C2/E2/F2 (current signal) is as follows.

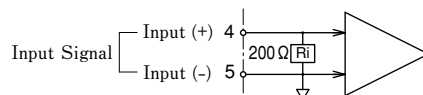

2. Pins 9 and 10 are used only for the models LSVHG- *EH- * - * - *E* with a fail-safe solenoid operated valve.

LSVHG-03EH-230/270

Mounting Surface: Conforming to ISO 4401-05-05-0-94

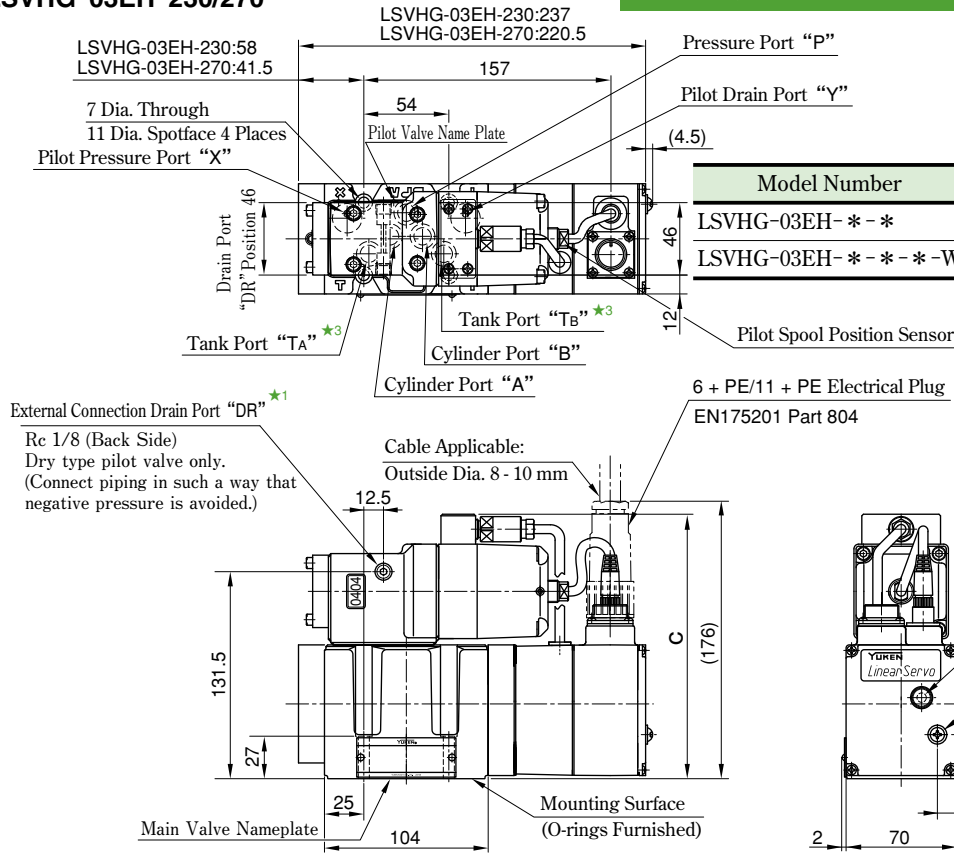

Model Number	C	Remarks
LSVHG-03EH- * - *	168	Pilot Valve: Dry Type
LSVHG-03EH- * - * - W	177	Pilot Valve: Wet Type

Color	Indicator Lamp
Green	Power Supply
Red	Pilot Valve Deviation Alarm
Yellow	Main Valve Deviation Alarm

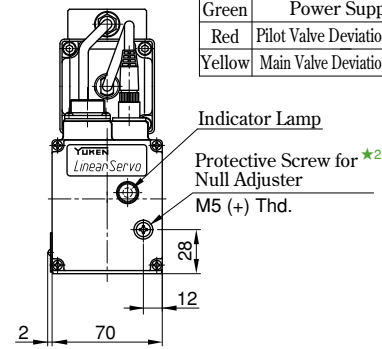

- *1. The external connection drain port "DR" on the front side is usually plugged. To use the port on the front side, remove the hexagon socket head plug (5 Hex.) and plug the port on the back side.
- *2. To adjust the null, remove the protective screw and turn the null trimmer. After adjustment, be sure to attach the protective screw.

**LSVHG-03EH-230/270- * - * EA/EB/EC
(With Fail-safe Solenoid Operated Valve)**

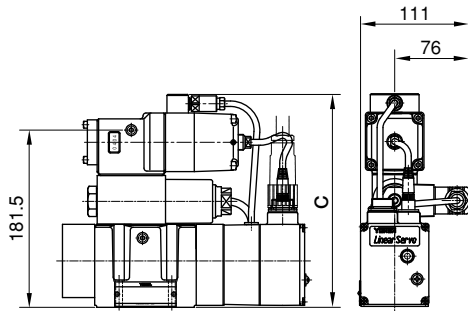

Detailed Graphic Symbol

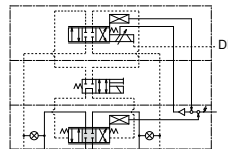

Note) The configuration in the shaded area varies with the selected spool type (corresponding to Graphic Symbols on page 30).

⊗: Plugs for selecting the pilot and drain types

[Dimensions of Mounting Surface]

Prepare a mounting surface shown below. Basically, the dimensions of the mounting surface conform to ISO 4401-05-05-0-94. The mounting surface should have a good machined finish.

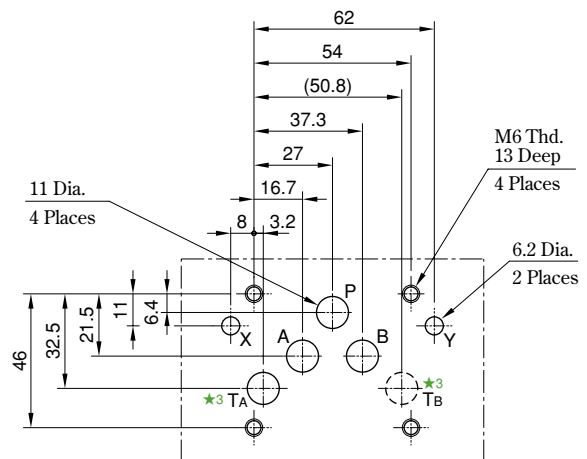

*3. There are two tank ports "TA" and "TB"; however, "TA" may be used alone.

Model Number	C	Remarks
LSVHG-03EH- * - * - E *	218	Pilot Valve: Dry Type
LSVHG-03EH- * - * - WE *	227	Pilot Valve: Wet Type

● For other dimensions, see the figures above (the models without a fail-safe solenoid operated valve).

● O-rings for the Ports

Port	O-ring Size	Qty.
P, A, B, T	AS568-014 (NBR, Hs90)	5
X, Y	AS568-016 (NBR, Hs90)	2

O-rings made of fluorinated rubber are required to use phosphate ester type fluids.

LSVHG-04EH-750

Model Number	C	Remarks
LSVHG-04EH-750-*	194	Pilot Valve: Dry Type
LSVHG-04EH-750- *-W	203	Pilot Valve: Wet Type

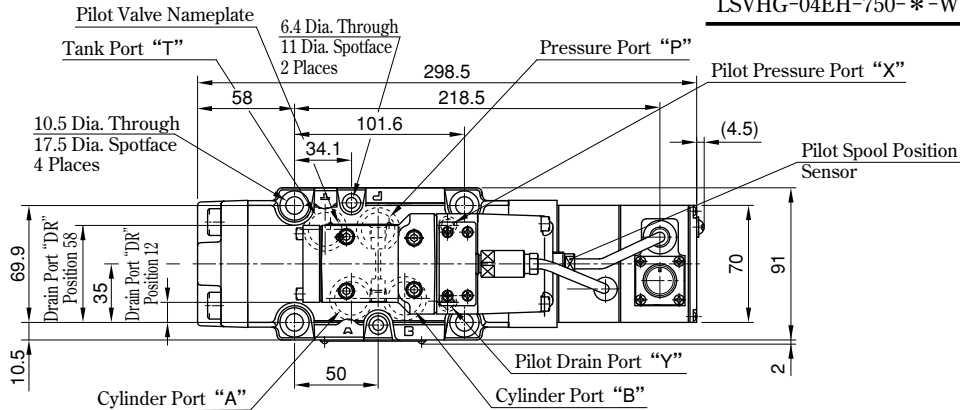

External Connection Drain Port "DR"
Rc 1/8 (Back Side)
Dry type pilot valve only.
(Connect piping in such a way that negative pressure is avoided.)

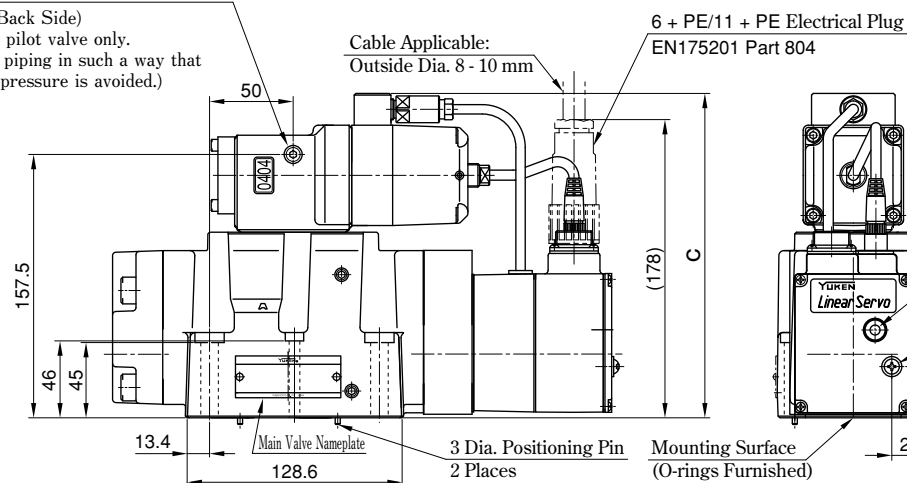

- ★1. The external connection drain port "DR" on the front side is usually plugged. To use the port on the front side, remove the hexagon socket head plug (5 Hex.) and plug the port on the back side.
- ★2. To adjust the null, remove the protective screw and turn the null trimmer. After adjustment, be sure to attach the protective screw.

LSVHG-04EH-750- *- * EA/EB/EC (With Fail-safe Solenoid Operated Valve)

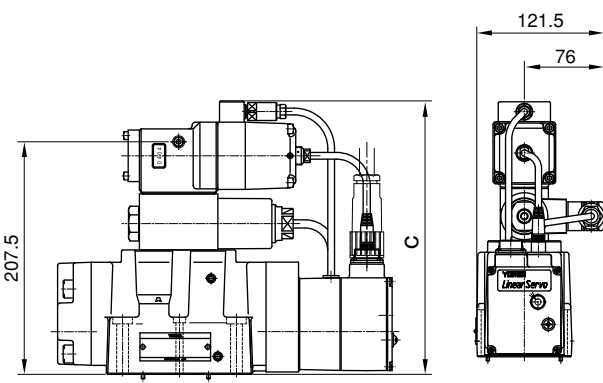

Detailed Graphic Symbol

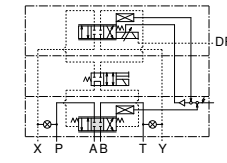

Note) The configuration in the shaded area varies with the selected spool type (corresponding to Graphic Symbols on page 30).

⊗ : Plugs for selecting the pilot and drain types

Model Number	C	Remarks
LSVHG-04EH-750- *-E*	244	Pilot Valve: Dry Type
LSVHG-04EH-750- *-WE*	253	Pilot Valve: Wet Type

● For other dimensions, see the figures above (the models without a fail-safe solenoid operated valve).

● O-rings for the Ports

Port	O-ring Size	Qty.
P, A, B, T	JIS B2401-1B-P22	4
X, Y	AS568-012 (NBR, Hs90)	2

O-rings made of fluorinated rubber are required to use phosphate ester type fluids.

【Dimensions of Mounting Surface】

The dimensions of the mounting surface are the same as those of the models LSVHG-04 (page 11).

LSVHG-06EH-900/1300

Model Number	C	Remarks
LSVHG-06EH-**-*	244	Pilot Valve: Dry Type
LSVHG-06EH-***-W	253	Pilot Valve: Wet Type

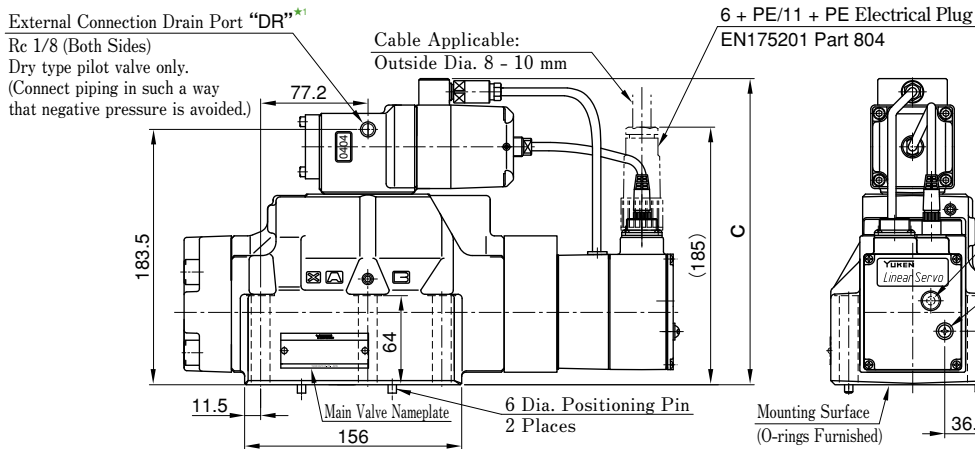
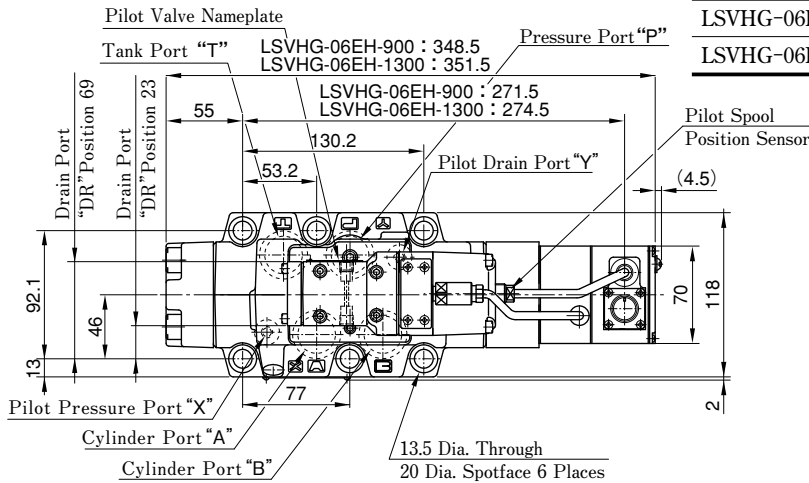

Color	Indicator Lamp
Green	Power Supply
Red	Pilot Valve Deviation Alarm
Yellow	Main Valve Deviation Alarm

- ★1. The external connection drain port "DR" on the back side is usually plugged. To use the port on the back side, remove the hexagon socket head plug (Hex. 5) and plug the port on the front side.
- ★2. To adjust the null, remove the protective screw and turn the null trimmer. After adjustment, be sure to attach the protective screw.

LSVHG-06EH-900/1300--*EA/EB/EC (With Fail-safe Solenoid Operated Valve)**

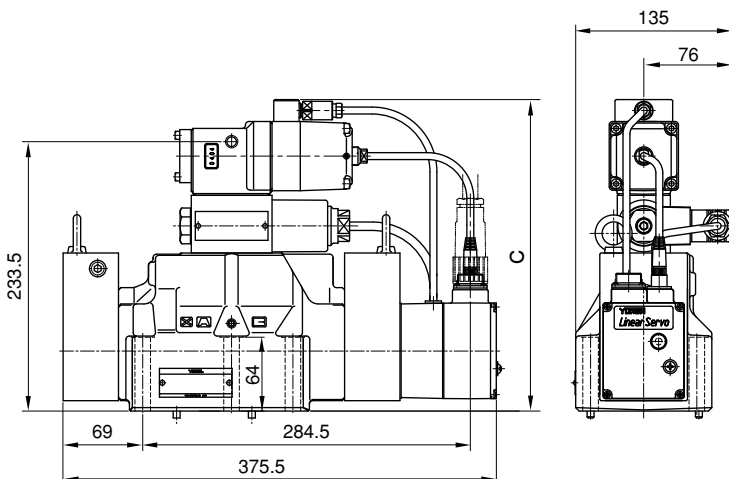

Detailed Graphic Symbol

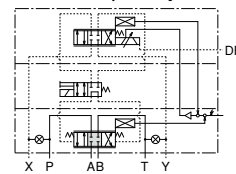

⊗ : Plugs for selecting the pilot and drain types

Note) The configuration in the shaded area varies with the selected spool type (corresponding to Graphic Symbols on page 30).

Model Number	C	Remarks
LSVHG-06EH-**-*-E*	270	Pilot Valve: Dry Type
LSVHG-06EH-**-*-WE*	279	Pilot Valve: Wet Type

● For other dimensions, see the figures above (the models without a fail-safe solenoid operated valve).

● O-rings for the Ports

Port	O-ring Size		Qty.
	LSVHG-06EH-900	LSVHG-06EH-1300	
P, A, B, T	AS568-123 (NBR ,Hs90)	AS568-126 (NBR ,Hs90)	4
X, Y	JIS B2401-1B-P14		2

O-rings made of fluorinated rubber are required to use phosphate ester type fluids.

[Dimensions of Mounting Surface]

The dimensions of the mounting surface are the same as those of the models LSVHG-06 (page 12).

LSVHG-10EH-3800

Model Number	C	Remarks
LSVHG-10EH-**-*	343	Pilot Valve: Dry Type
LSVHG-10EH-***-W	352	Pilot Valve: Wet Type

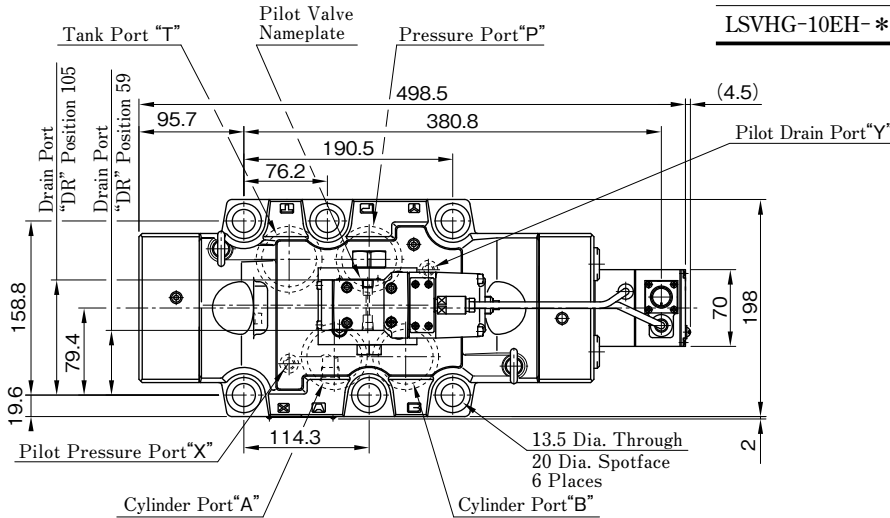

External Connection Drain Port*1
Rc 1/8 (Both Sides)
Dry type pilot valve only.
(Connect piping in such a way
that negative pressure is avoided.)

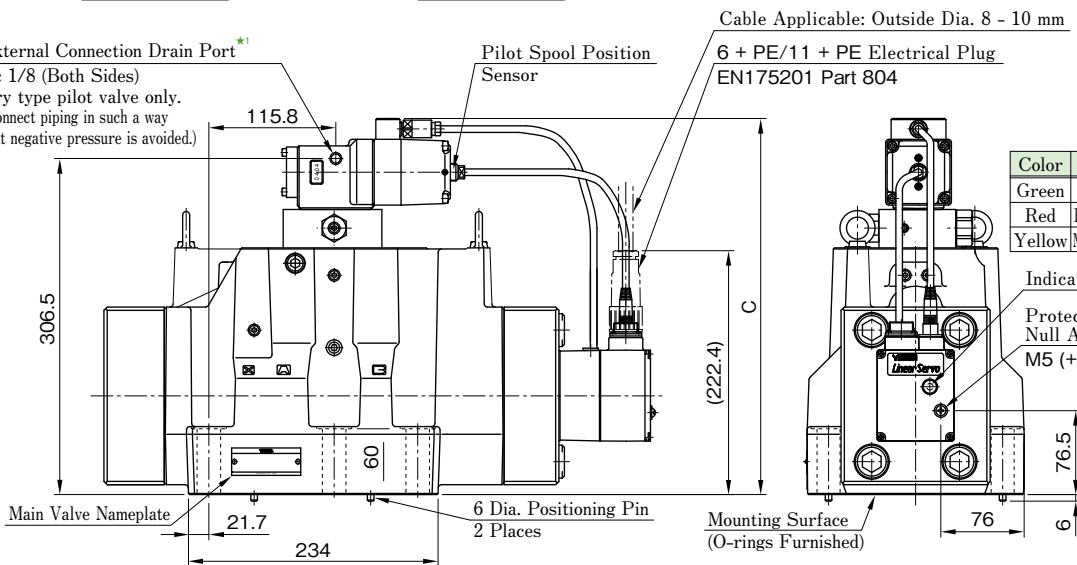

Color	Indicator Lamp
Green	Power Supply
Red	Pilot Valve Deviation Alarm
Yellow	Main Valve Deviation Alarm

Indicator Lamp
Protective Screw for
Null Adjuster
M5 (+) Thd.

- ★1. The external connection drain port "DR" on the back side is usually plugged. To use the port on the back side, remove the hexagon socket head plug (Hex. 5) and plug the port on the front side.
- ★2. To adjust the null, remove the protective screw and turn the null trimmer. After adjustment, be sure to attach the protective screw.

[Dimensions of Mounting Surface]

The dimension of the mounting surface can be fitted with ISO standard.
However, the hole dia. of P,A,B,T are different with those.
Please see mounting surface as shown right.

	ISO 4401-10-08-0-94	Mounting Surface for LSVHG-10EH
Hole dia. Of P,A,B,T port.	36 Dia.	50 Dia.

The mounting surface should have a good machined finish.

● O-rings for the Ports

Port	O-ring Size	Qty.
P, A, B, T	AS568-227 (NBR, Hs 90)	4
X, Y	AS568-015 (NBR, Hs 90)	2

O-rings made of fluorinated rubber are required to use phosphate ester type fluids.

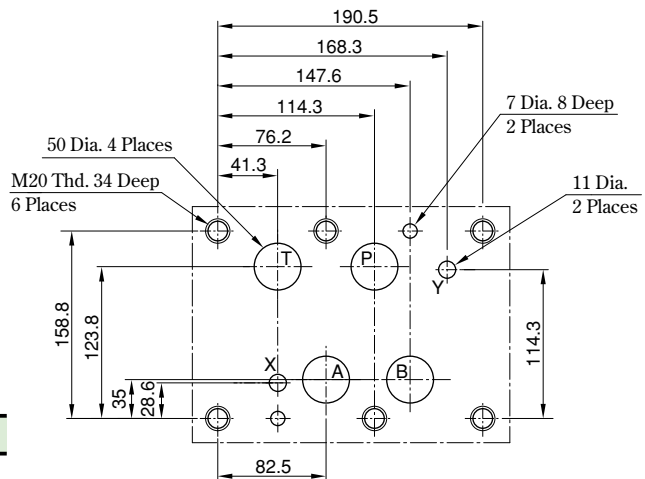

Characteristics of LSVHG-03EH-230 (Fluid Viscosity: 30 mm²/s)

No-Load Flow Characteristics

◁Conditions> ●Valve Pressure Difference: 1 MPa (Pressure Difference per Land: 0.5 MPa)
 Around Null Position Input Signal -20 ⇔ +20 %

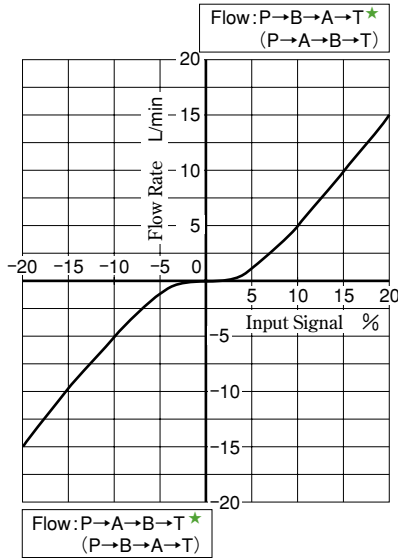
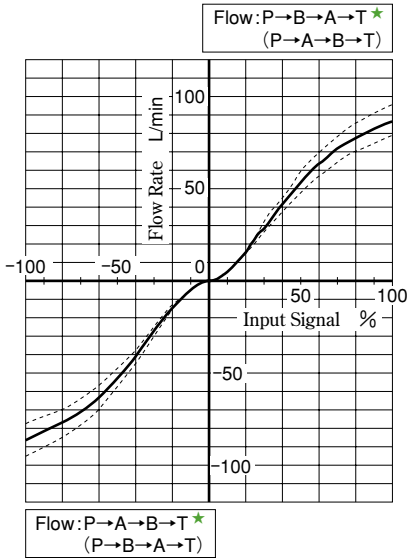

Load Flow Characteristics

◁Conditions> ●Input Signal : 100 %
 Note) Tolerance for Load Flow : ±10 %

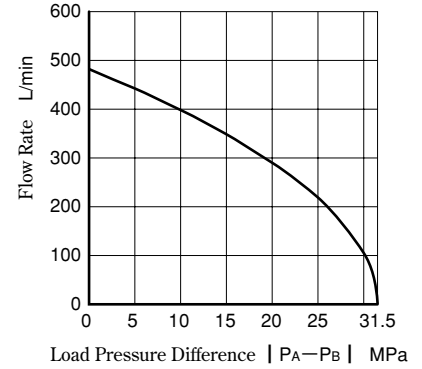

★ The flow outside of parentheses is achieved when the input signal type "A", "B", or "C" is selected. The flow in parentheses is achieved when "D", "E", or "F" is selected.

Step Response

◁Conditions> ●Input Signal : 0 ⇔ 100 % ●Supply/Pilot Pressure力 : 14 MPa

Pilot Valve: Dry Type

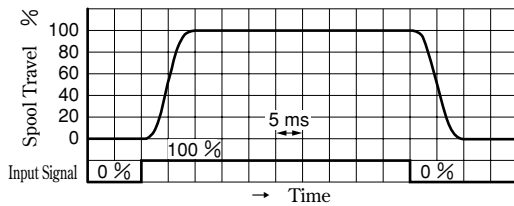

Pilot Valve: Wet Type

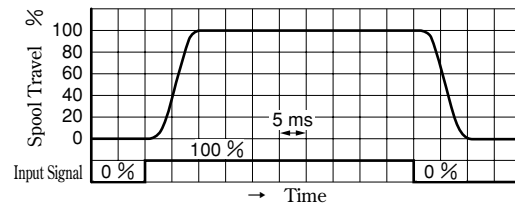

Frequency Response

◁Conditions> ●Hydraulic Circuit: Port A/B Closed ●Supply/Pilot Pressure : 14 MPa

Pilot Valve: Dry Type

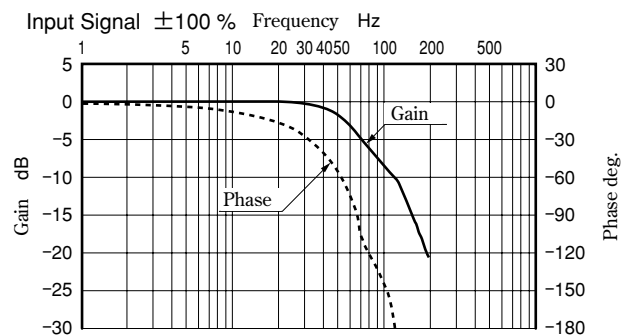
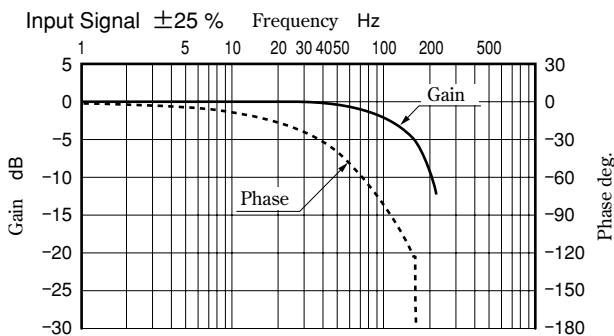

Pilot Valve: Wet Type

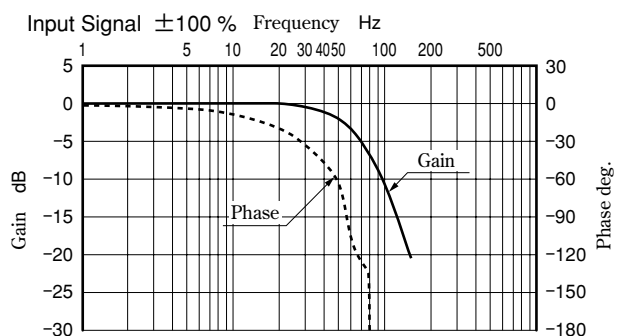
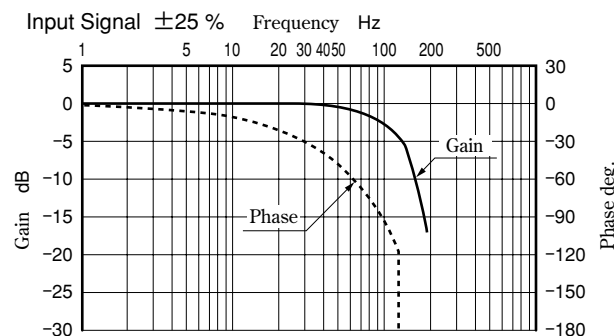

Characteristics of LSVHG-03EH-270-2/40/2P (Fluid Viscosity: 30 mm²/s)

No-Load Flow Characteristics

<Conditions> ● Valve Pressure Difference: 1 MPa (Pressure Difference per Land: 0.5 MPa)

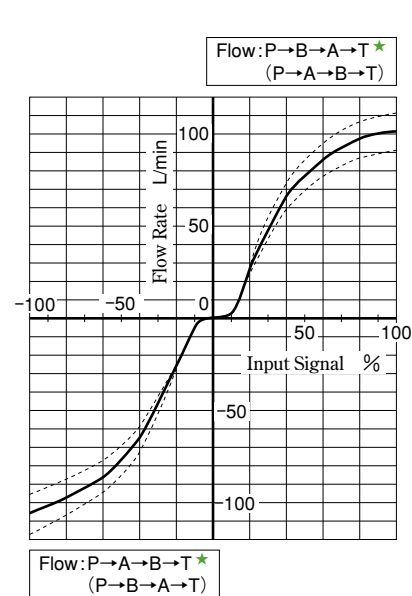

Around Null Position Input Signal -20 ↔ +20 %

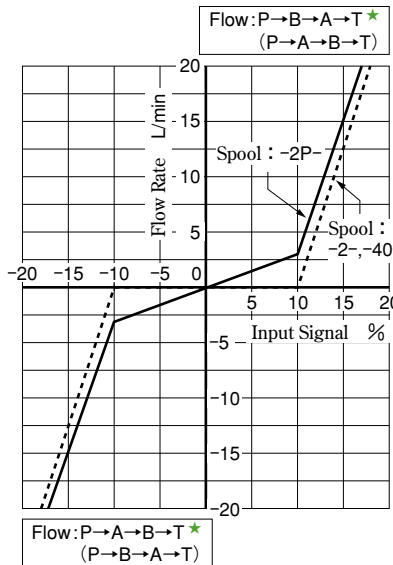

Load Flow Characteristics

<Conditions>

● Input Signal : 100 %

Note) Tolerance for Load Flow : ±10 %

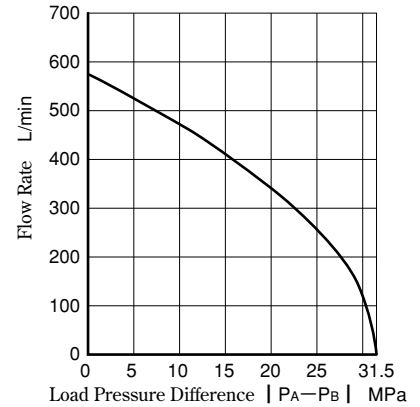

★ The flow outside of parentheses is achieved when the input signal type "A", "B", or "C" is selected. The flow in parentheses is achieved when "D", "E", or "F" is selected.

Step Response

<Conditions> ● Input Signal : 0 ↔ 100 % ● Supply/Pilot Pressure : 14 MPa

● Pilot Valve: Dry Type

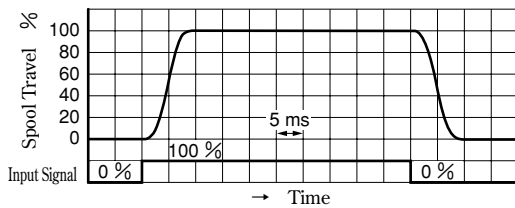

● Pilot Valve: Wet Type

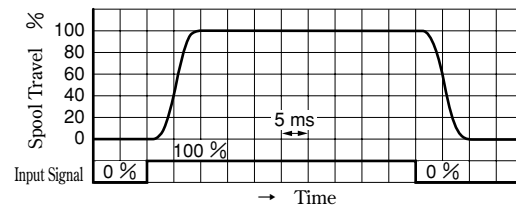

Frequency Response

<Conditions> ● Hydraulic Circuit: Port A/B Closed ● Supply/Pilot Pressure : 14 MPa

● Pilot Valve: Dry Type

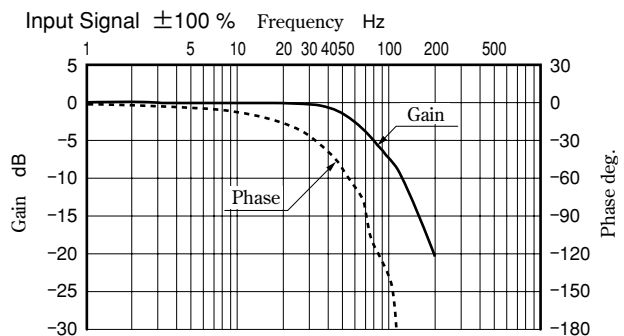
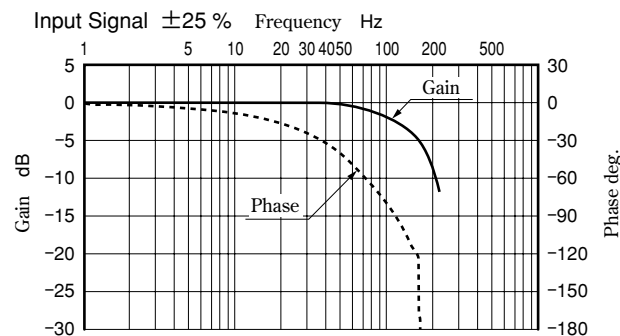

● Pilot Valve: Wet Type

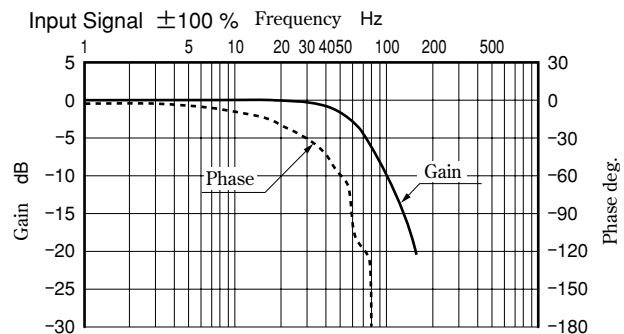
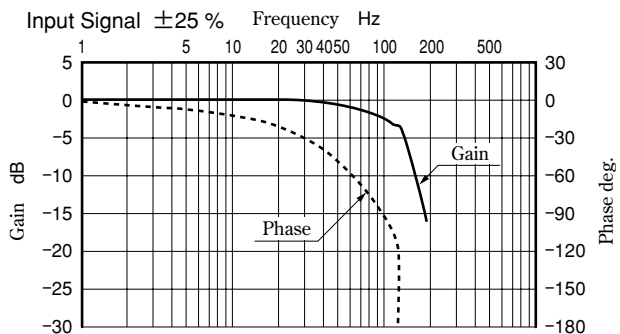

Characteristics of LSVHG-03EH-210-4J (Fluid Viscosity: 30 mm²/s)

No-Load Flow Characteristics

<Conditions> ● Valve Pressure Difference: $\Delta P = 0.5 \text{ MPa}$ (per Land)

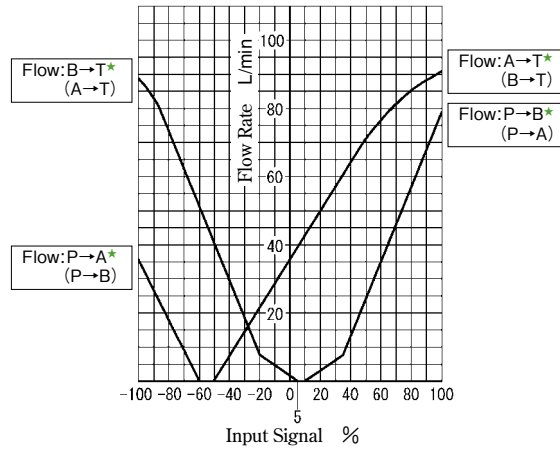

★ The flow outside of parentheses is achieved when the input signal type "A", "B", or "C" is selected. The flow in parentheses is achieved when "D", "E", or "F" is selected.

Characteristics of LSVHG-04EH-750-2/40/2P (Fluid Viscosity: 30 mm²/s)

No-Load Flow Characteristics

<Conditions> ● Valve Pressure Difference: 1 MPa (Pressure Difference per Land: 0.5 MPa)
 Around Null Position Input Signal -20 ⇔ +20 %

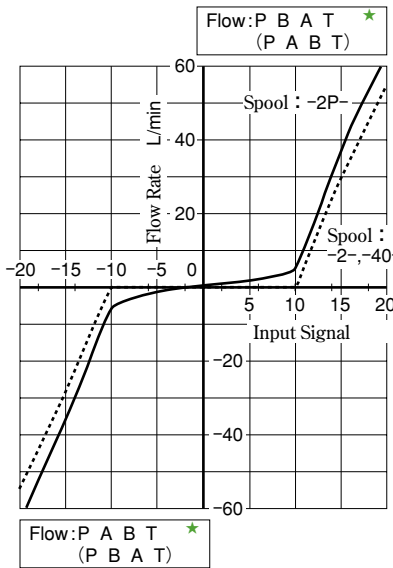
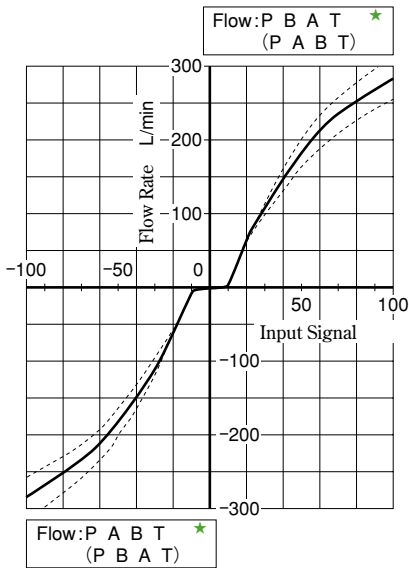

Load Flow Characteristics

<Conditions> ● Input Signal : 100 %
 Note) Tolerance for Load Flow : ±10 %

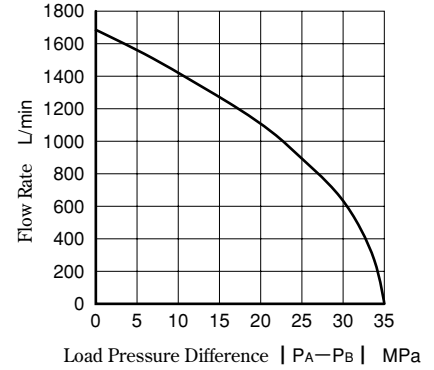

★ The flow outside of parentheses is achieved when the input signal type "A", "B", or "C" is selected. The flow in parentheses is achieved when "D", "E", or "F" is selected.

Step Response

<Conditions> ● Input Signal : 0 ⇔ 100 % ● Supply/Pilot Pressure : 14 MPa

● Pilot Valve: Dry Type

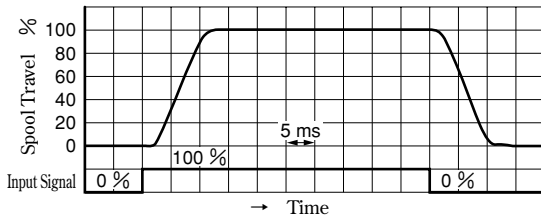

● Pilot Valve: Wet Type

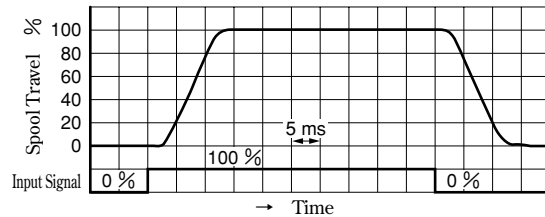

Frequency Response

<Conditions> ● Hydraulic Circuit: Port A/B Closed ● Supply/Pilot Pressure : 14 MPa

● Pilot Valve: Dry Type

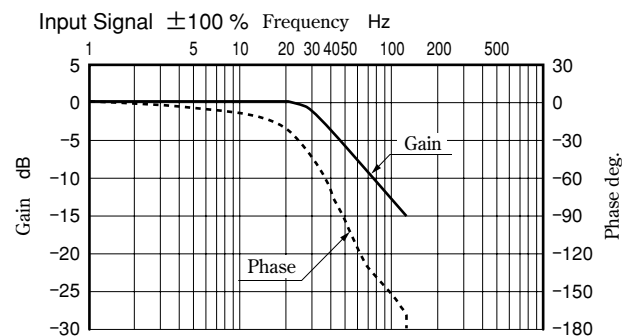
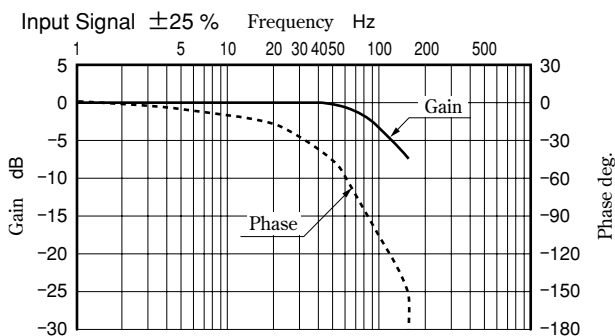

● Pilot Valve: Wet Type

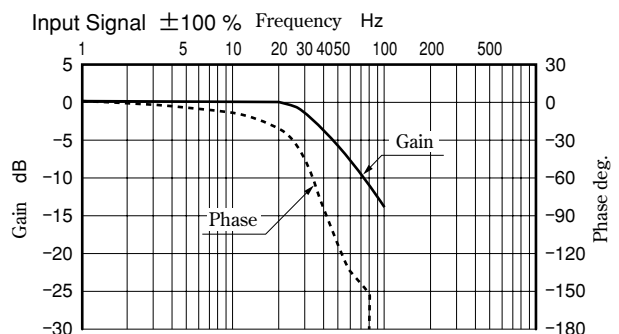
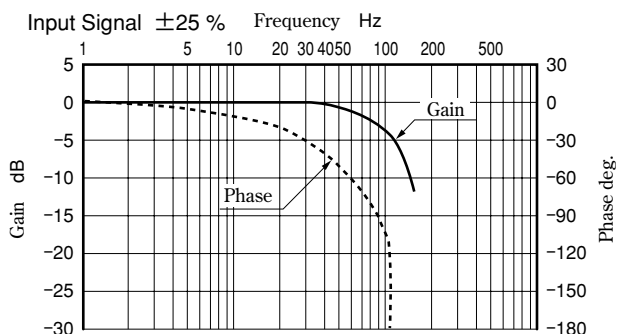

Characteristics of LSVHG-04EH-750-2L (Fluid Viscosity: 30 mm²/s)

No-Load Flow Characteristics

〈Conditions〉 ● Valve Pressure Difference: $\Delta P = 1$ MPa (4-Way Valve) (Pressure Difference per Land: 0.5 MPa)

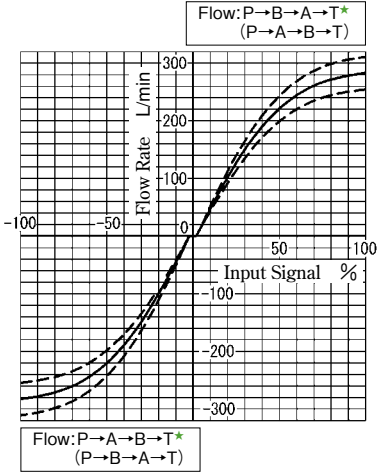

Around Null Position Input Signal -20 \leftrightarrow +20 %

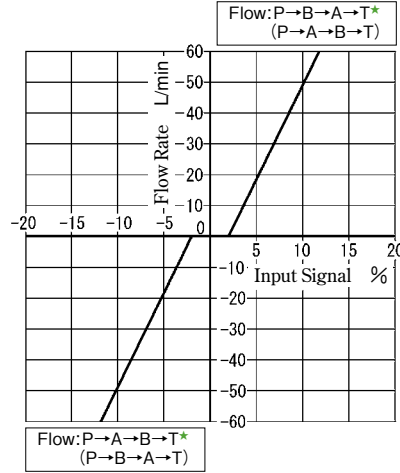

The load flow characteristics, step response, and frequency response are the same as those of the spool types "2", "40", and "2P".

★ The flow outside of parentheses is achieved when the input signal type "A", "B", or "C" is selected. The flow in parentheses is achieved when "D", "E", or "F" is selected.

Characteristics of LSVHG-04EH-580-4J (Fluid Viscosity: 30 mm²/s)

No-Load Flow Characteristics

〈Conditions〉 ● Valve Pressure Difference: $\Delta P = 0.5$ MPa (per Land)

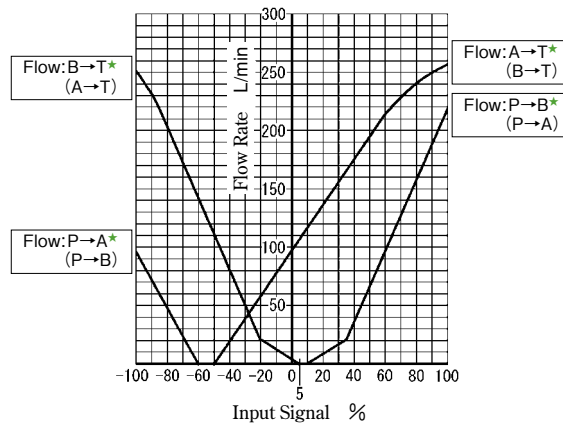

★ The flow outside of parentheses is achieved when the input signal type "A", "B", or "C" is selected. The flow in parentheses is achieved when "D", "E", or "F" is selected.

Characteristics of LSVHG-06EH-900-2/40/2P (Fluid Viscosity: 30 mm²/s)

No-Load Flow Characteristics

<Conditions> ● Valve Pressure Difference: 1 MPa (Pressure Difference per Land: 0.5 MPa)
 Around Null Position Input Signal -20 ⇔ +20 %

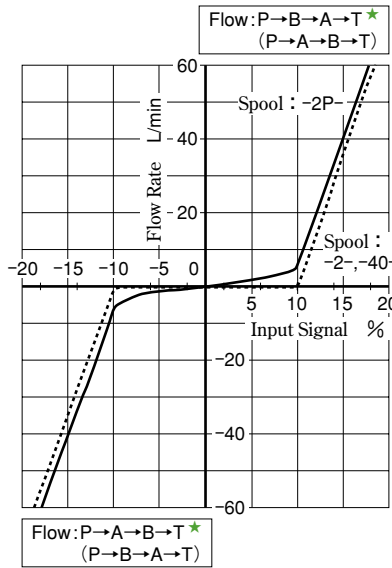
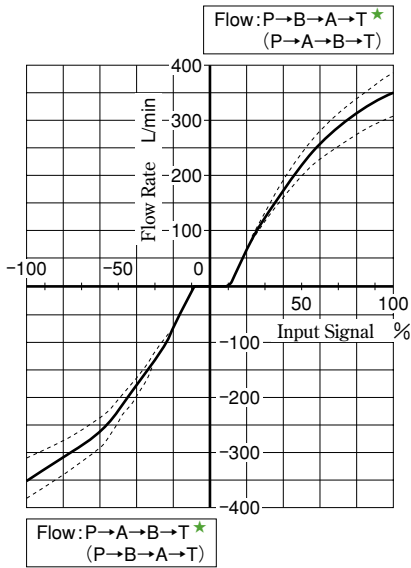

Load Flow Characteristics

<Conditions> ● Input Signal : 100 %
 Note) Tolerance for Load Flow : ±10 %

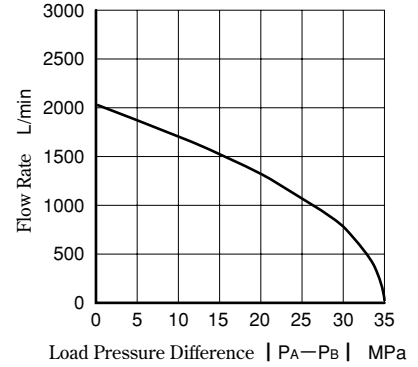

★ The flow outside of parentheses is achieved when the input signal type "A", "B", or "C" is selected. The flow in parentheses is achieved when "D", "E", or "F" is selected.

Step Response

<Conditions> ● Input Signal : 0 ⇔ 100 % ● Supply/Pilot Pressure : 14 MPa

Pilot Valve: Dry Type

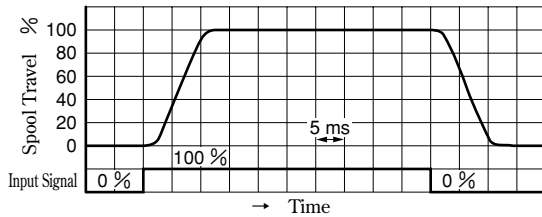

Pilot Valve: Wet Type

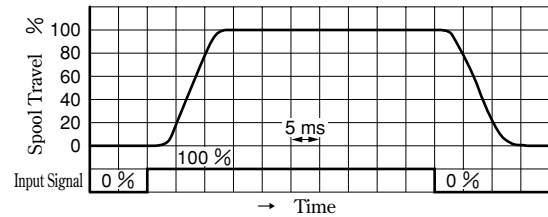

Frequency Response

<Conditions> ● Hydraulic Circuit: Port A/B Closed ● Supply/Pilot Pressure : 14 MPa

Pilot Valve: Dry Type

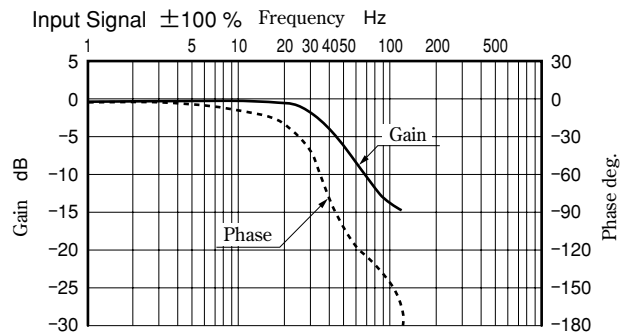
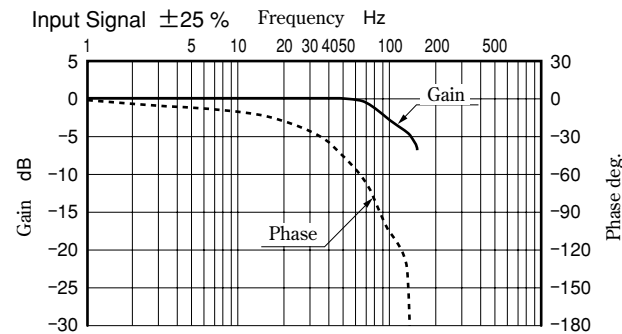

Pilot Valve: Wet Type

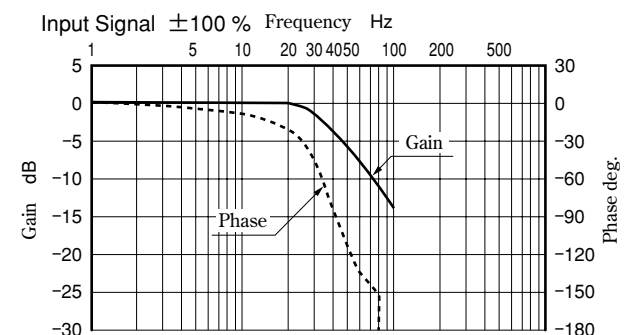
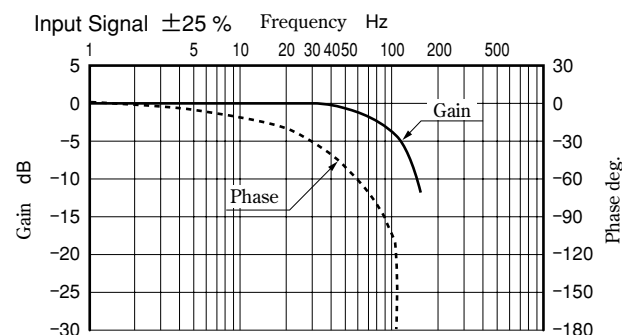

Characteristics of LSVHG-06EH-900-2L (Fluid Viscosity: 30 mm²/s)

No-Load Flow Characteristics <Conditions> ● Valve Pressure Difference: $\Delta P = 1$ MPa (4-Way Valve) (Pressure Difference per Land: 0.5 MPa)

Around Null Position Input Signal -20 \leftrightarrow +20 %

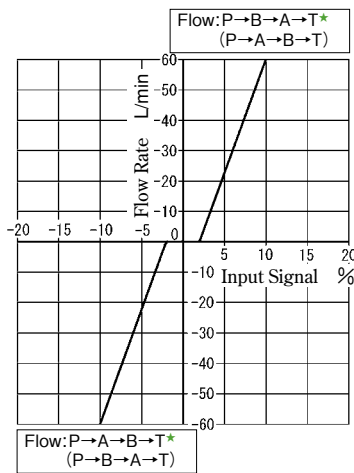
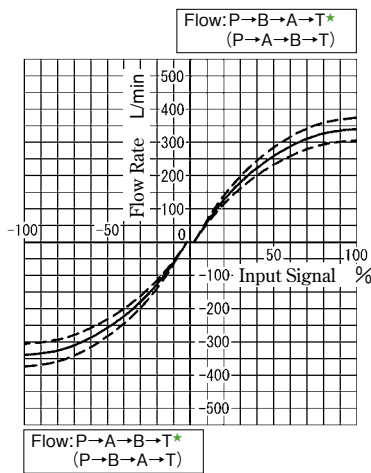

The load flow characteristics, step response, and frequency response are the same as those of the spool types "2", "40", and "2P".

★ The flow outside of parentheses is achieved when the input signal type "A", "B", or "C" is selected. The flow in parentheses is achieved when "D", "E", or "F" is selected.

Characteristics of LSVHG-06EH-1300-2L (Fluid Viscosity: 30 mm²/s)

No-Load Flow Characteristics <Conditions> ● Valve Pressure Difference: $\Delta P = 1$ MPa (4-Way Valve) (Pressure Difference per Land: 0.5 MPa)

Around Null Position Input Signal -20 \leftrightarrow +20 %

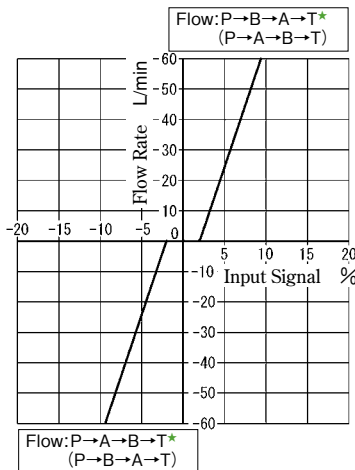
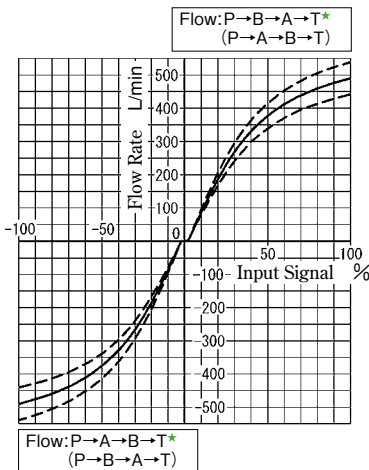

The load flow characteristics, step response, and frequency response are the same as those of the spool types "2", "40", and "2P".

★ The flow outside of parentheses is achieved when the input signal type "A", "B", or "C" is selected. The flow in parentheses is achieved when "D", "E", or "F" is selected.

Characteristics of LSVHG-06EH-820/1300-4J (Fluid Viscosity: 30 mm²/s)

No-Load Flow Characteristics <Conditions> ● Valve Pressure Difference: $\Delta P = 0.5$ MPa (per Land)

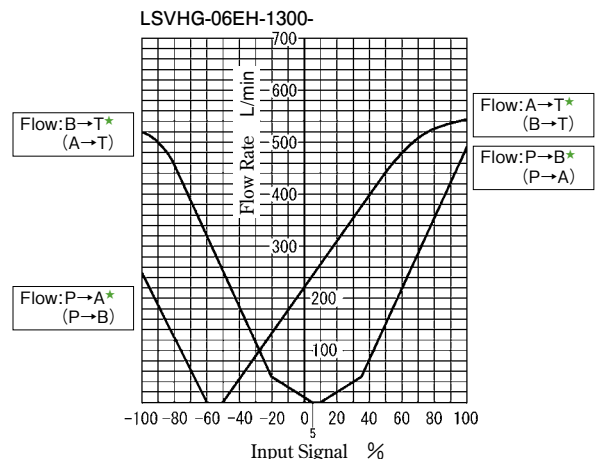
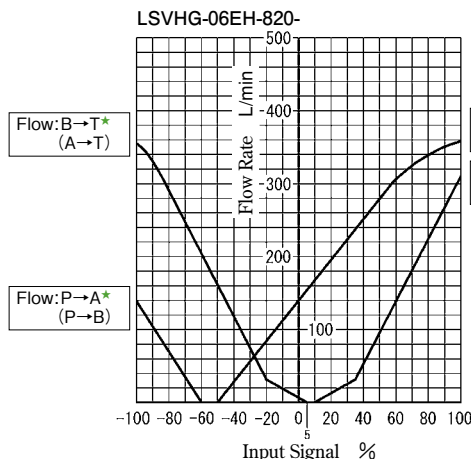

★ The flow outside of parentheses is achieved when the input signal type "A", "B", or "C" is selected. The flow in parentheses is achieved when "D", "E", or "F" is selected.

Characteristics of LSVHG-06EH-1300-2/40/2P (Fluid Viscosity: 30 mm²/s)

No-Load Flow Characteristics

<Conditions> ● Valve Pressure Difference: 1 MPa (Pressure Difference per Land: 0.5 MPa)
 Around Null Position Input Signal -20 ↔ +20 %

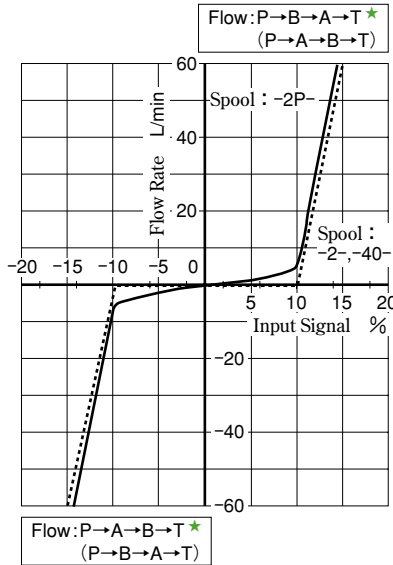
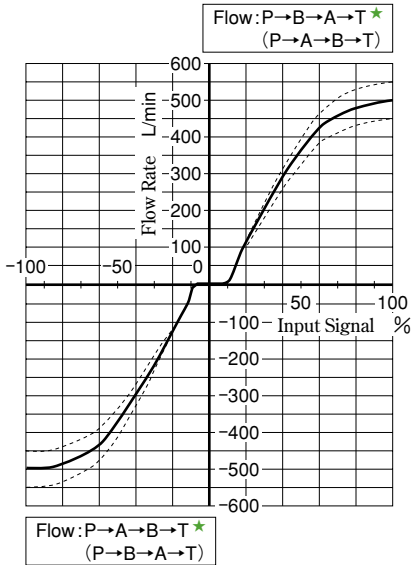

Load Flow Characteristics

<Conditions> ● Input Signal : 100 %
 Note) Tolerance for Load Flow : ±10 %

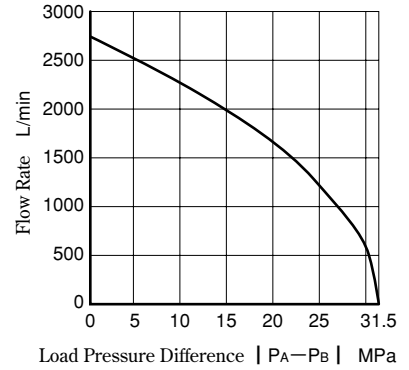

★ The flow outside of parentheses is achieved when the input signal type "A", "B", or "C" is selected. The flow in parentheses is achieved when "D", "E", or "F" is selected.

Step Response

<Conditions> ● Input Signal : 0 ↔ 100 % ● Supply/Pilot Pressure : 14 MPa

● Pilot Valve: Dry Type

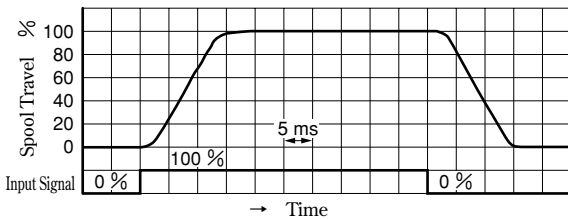

● Pilot Valve: Wet Type

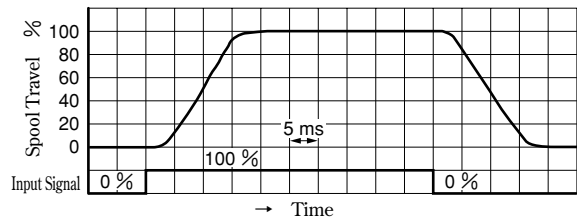

Frequency Response

<Conditions> ● Hydraulic Circuit: Port A/B Closed ● Supply/Pilot Pressure : 14 MPa

● Pilot Valve: Dry Type

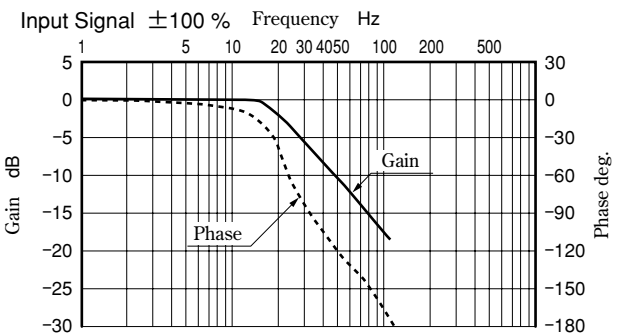
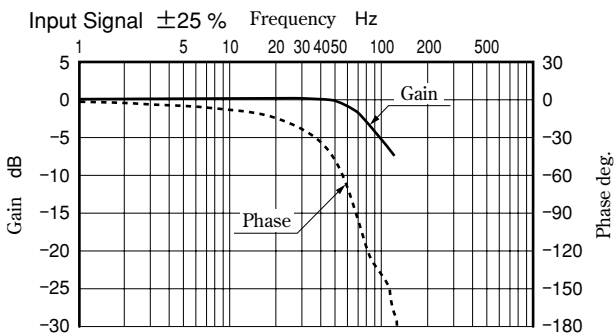

● Pilot Valve: Wet Type

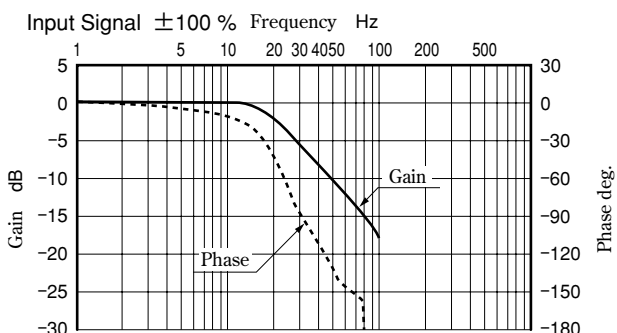
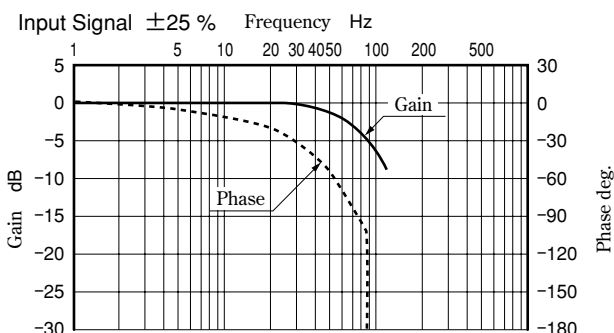

Characteristics of LSVHG-10EH-3800-2/40/2P (Fluid Viscosity: 30 mm²/s)

No-Load Flow Characteristics

<Conditions> ● Valve Pressure Difference: 1 MPa (Pressure Difference per Land: 0.5 MPa)
 Around Null Position Input Signal -20 ⇔ +20 %

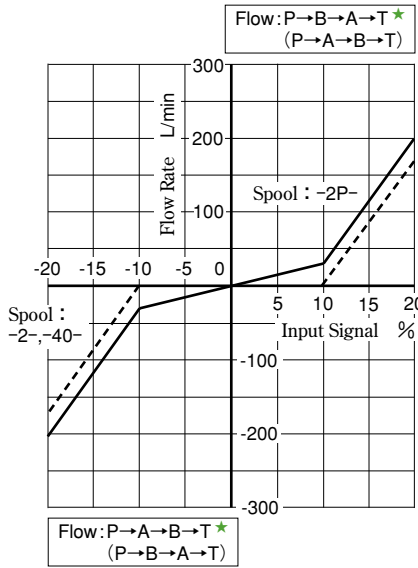
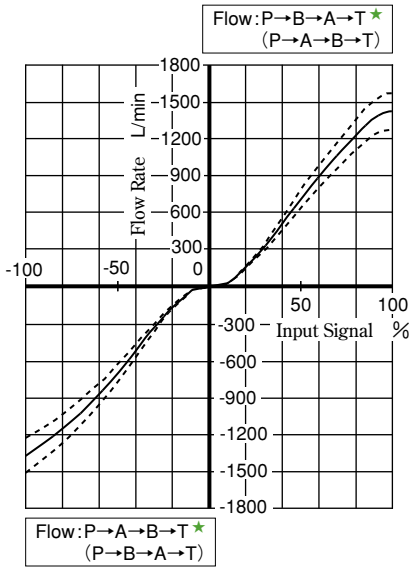

Load Flow Characteristics

<Conditions> ● Input Signal : 100 %
 Note) Tolerance for Load Flow : ±10 %

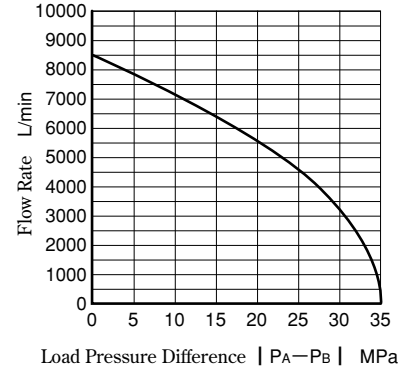

★ The flow outside of parentheses is achieved when the input signal type "A", "B", or "C" is selected. The flow in parentheses is achieved when "D", "E", or "F" is selected.

Step Response

<Conditions> ● Input Signal : 0 ⇔ 100 % ● Supply/Pilot Pressure : 14 MPa

● Pilot Valve: Dry Type

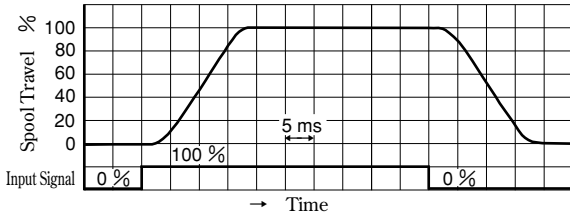

● Pilot Valve: Wet Type

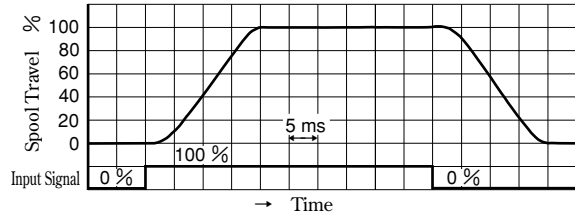

Frequency Response

<Conditions> ● Hydraulic Circuit: Port A/B Closed ● Supply/Pilot Pressure : 14 MPa

● Pilot Valve: Dry Type

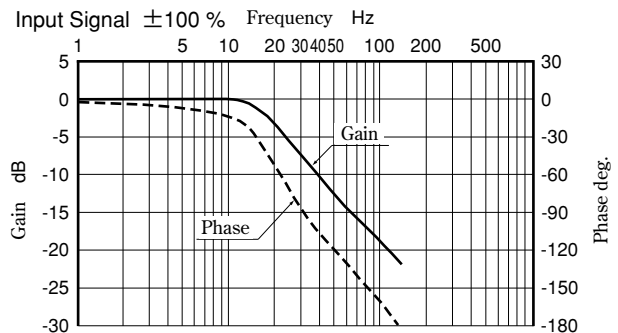
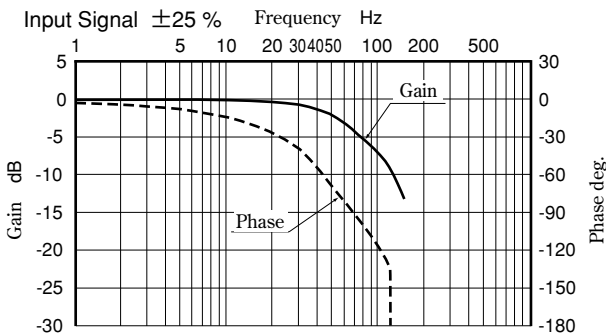

● Pilot Valve: Wet Type

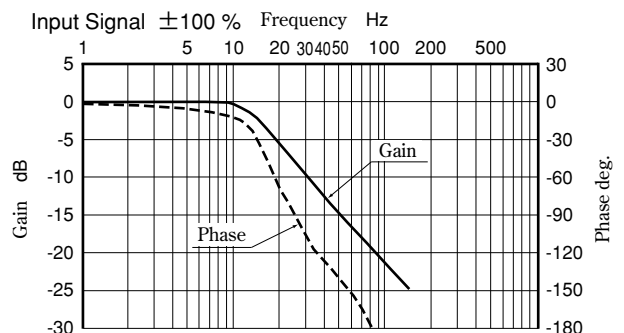
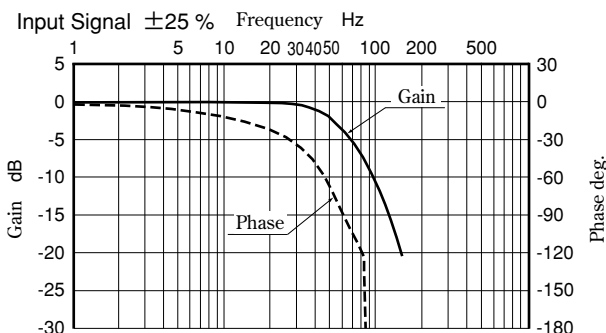

Characteristics of LSVHG-10EH-3800-2L (Fluid Viscosity: 30 mm²/s)

No-Load Flow Characteristics

<Conditions> ● Valve Pressure Difference: $\Delta P = 1$ MPa (4-Way Valve) (Pressure Difference per Land: 0.5 MPa)

Around Null Position Input Signal -20 \leftrightarrow +20 %

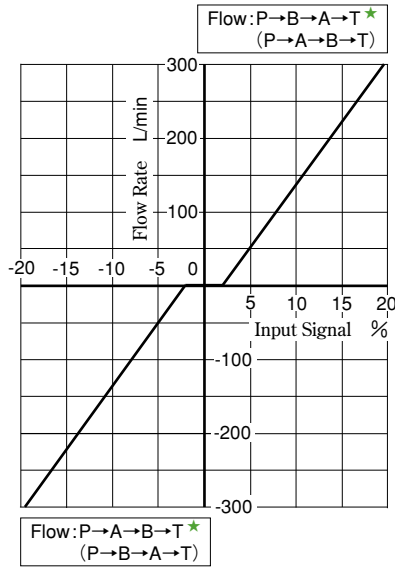
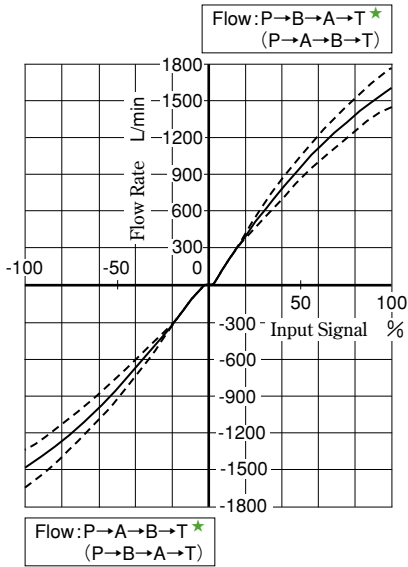

The load flow characteristics, step response, and frequency response are the same as those of the spool types "2", "40", and "2P".

★ The flow outside of parentheses is achieved when the input signal type "A", "B", or "C" is selected. The flow in parentheses is achieved when "D", "E", or "F" is selected.

OBE (on-Board Electronic) type Linear Servo Valves (High Performance Type)

On-board electronics (OBE) type linear servo valves (high performance type) are produced for achieving higher accuracy and durability by incorporating a sleeve in the main stage of the OBE type linear servo valves (standard type), which have been well accepted for their "high accuracy, easiness to use, and great usability". Since the spool and the sleeve are processed to fit well and properly keep 1% overlap between one another, they are suited to be used for a system requiring high accuracy and durability.

● **High accuracy**

As is the case with the standard type valves, all of the OBE type linear servo valves (high performance type) have a low hysteresis of 0.1 % or less, realizing high accuracy. These valves allow the main unit to operate with much higher repeatability.

● **High response characteristics**

Compared to other equivalent models, these valves provide higher levels of step and frequency responses, which are typically used as measures of response characteristics; the step response is 7 ms (0 <=> 100 %)★, and the frequency response is 110 Hz/-3 dB (± 25 % amplitude)★. (★ : Representative values for LSVHG-03EH- * -S *)

● **Easiness to use**

These valves can offer high accuracy for hydraulic control systems just with 24 V DC power supply and command signal input.

Six types of input signals in three input voltage/current ranges are available:
0 - ±10 V, 0 - ±10 mA, and 4 - 20 mA.

● **Great usability**

The small amplifier in the valves has a fault indicator lamp. This lamp indicates an error when valve failure causes any deviation between the spool position commanded by the signal and the actual spool position. It facilitates you to immediately troubleshoot the failure of the valves, if any.

● **Excellent contamination resistance**

As is the case with the high speed linear servo valves, the OBE type linear servo valves have a simple pilot valve structure, exhibiting excellent contamination resistance. The permissible level of fluid contamination for these valves is up to NAS 1638 class 10.

● **Two types of pilot valves available**

There are two types of pilot valves available: a dry type good in response characteristics and a wet type that eliminates the drain (DR) port to improve usability. They can be selected according to users' purposes.

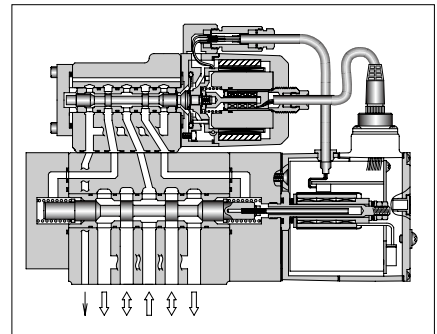
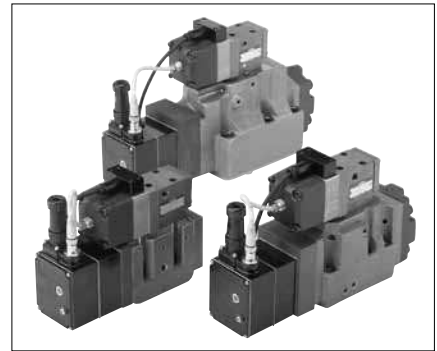

Graphic Symbols

● **4-Way Valve**

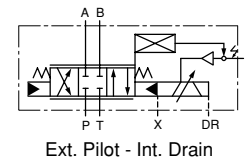
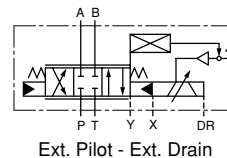
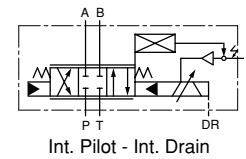
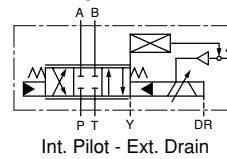

● **3-Way Valve**

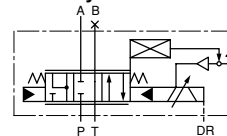

Note) The pilot/drain types are the same as those for the "4-Way Valve" shown above.

■ **Model Number Designation**

F—	LSVHG	—06	EH	—900	—S	4	—E	T	—W	A	—A	1	—20
Fluid Type	Series Number	Valve Size	Amp. Type	Rated Flow @ ΔP=7 MPa	Spool Type	Control Type	Pilot Type	Drain Type	DR Port and Permissible Back Pres.	Fail-safe Function	Input Signal/ Spool Travel Monitoring	Connector Type	Design Number
F : Special Seals for Phosphate Ester Type Fluid (Omit if not required)	LSVHG : Two Stage Type Linear Servo Valves	03	EH : OBE Type	60 : 60 L/min 100 : 100 L/min 160 : 160 L/min	S : 1 % Overlap	3 : 3-Way Valve★1 (Port A is used.) 4 : 4-Way Valve	None: Internal Pilot	None: External Drain	None: With DR Port (Permissible Back Pres.: 0.05 MPa)	None: Position Valve Opening: Full	A: Voltage Signal ± 10 V (P→B→A→T Flow with Input Signal (+)) B: Current Signal 4 - 20 mA (P→B→A→T Flow with Current Signal 12 - 20 mA) C: Current Signal ± 10 mA (P→B→A→T Flow with Input Signal (+)) D: Voltage Signal ± 10 V (P→A→B→T Flow with Input Signal (+)) E: Current Signal 4 - 20 mA (P→A→B→T Flow with Current Signal 12 - 20 mA) F: Current Signal ± 10 mA (P→A→B→T Flow with Input Signal (+))	1: 6+ PE Pole 2: 11+ PE Pole	20
		04		100 : 100 L/min 200 : 200 L/min 280 : 280 L/min 450 : 450 L/min									
		06		500 : 500 L/min 900 : 900 L/min									

★1. For the valves with a 3-way valve and a fail-save solenoid operated valve, select "EB" for the fail-safe function type and "D", "E", or "F" for the input signal/spool travel monitoring type.
★2. The valves with the model number "W" (without DR port) cannot use water-glycol fluids.

Specifications The values in parentheses in the specification table below are applicable to the models “LSVHG-*EH-*S*-*W*.” (without DR port).

Description		Model Numbers						LSVHG-03EH- *-S*						LSVHG-04EH- *-S*						LSVHG-06EH- *-S*			
Spool Type		S4			S3			S4			S3			S4		S3							
Rated Flow @ ΔP = 7 MPa (4-Way Valve) L/min		60	100	160	—	—	—	100	200	280	450	—	—	—	—	500	900	—	—				
Rated Flow @ ΔP = 3.5 MPa (3-Way Valve) L/min		—	—	—	60	100	160	—	—	—	—	100	200	280	450	—	—	500	900				
Max. Operating Pressure MPa		31.5						35						35									
Proof Pres. at Return Port ⁽¹⁾	External Drain	T Port	21						31.5						35								
		Y Port	21 ⁽⁷⁾ (7)						21 (7)						21 (7)								
	Internal Drain	T & Y Ports	21 ⁽⁷⁾ (7)						21 (7)						21 (7)								
DR Port Permissible Back Pressure ⁽²⁾ MPa		0.05 (The valves with the model number “W” have no DR port.)																					
Pilot Pressure ⁽³⁾ MPa		1.5 - 21																					
Pilot Flow Rate ⁽⁴⁾ L/min		4 or more						6 or more						21 or more									
Pilot Valve Max. Leakage	Pres.: P _s = P _p = 14 MPa Fluid Viscosity: 32 mm ² /s	0.4																					
Main Valve Max. Leakage		0.6	1.1	2.1	0.3	0.6	1.1	0.9	1.7	2.5	5.0	0.5	0.9	1.3	2.5	1.9	4.8	1.0	2.4				
Hysteresis %		0.1 or less																					
Step Response (0 <=> 100 %, Typical) ⁽⁵⁾ ms		7 (8)						11 (12)						12 (13)									
Frequency Response (±25 % Amplitude Typical) ⁽⁶⁾	Gain: -3 dB	110 (80)						100 (80)						100 (80)									
	Phase: -90°	110 (90)						100 (90)						95 (90)									
Vibration Proof ⁽⁶⁾ m/s ²		100																					
Protection		IP 65																					
Ambient Temperature °C		0 - +50																					
Spool Stroke to Stops mm		±3.5						±3.5						±5									
Spool End Area cm ²		1.3						3.1						8									
Linear Motor Specification	Current	Max. 2.1																					
	Coil Resistance	9.6 [at 20 °C]																					
Approx. Mass ⁽⁸⁾ kg		8.5 [11]						14 [16]						20 [24]									
Mounting Surface		ISO 4401-05-05-0-94						ISO 4401-07-06-0-94						ISO 4401-08-07-0-94									
Electric Connection		6 + PE/11 + PE Connector (EN175201 Part 804)																					

- Note: ⁽¹⁾ Pressure at the return port should be at actual supply pressure or less.
⁽²⁾ Back pressure at the drain port should be 0.05 MPa or less and not be a negative pressure. For the valves with the model number “W” , no drain port connection is required.
⁽³⁾ Supply pressure for the pilot valve should be 1.5 - 21 MPa and should also be 60% of actual supply pressure or more.
⁽⁴⁾ The pilot flow is calculated based on a pilot pressure of 14 MPa and the above step response.
⁽⁵⁾ This value is measured for each valve based on a pilot pressure of 14 MPa; it may vary depending on the actual circuit/operation conditions.
⁽⁶⁾ There are restrictions on the mounting position; refer to the instructions for details.
⁽⁷⁾ To use an external pilot type valve with a supply pressure of 21 MPa or more, pressures at the T and Y ports should be 7 MPa or less.
⁽⁸⁾ A value in brackets indicates the mass of each valve with a fail-safe solenoid operated valve.
⁽⁹⁾ For the effective range of the fail-safe function, see page 59.

Attachment/Electrical Specifications/Block Diagram

These are the same as those of the standard type. See the relevant pages.

Item	Page for Reference
Attachment	34
Electrical Specifications	35
Block Diagram	36

LSVHG-03EH-60/100/160-S *

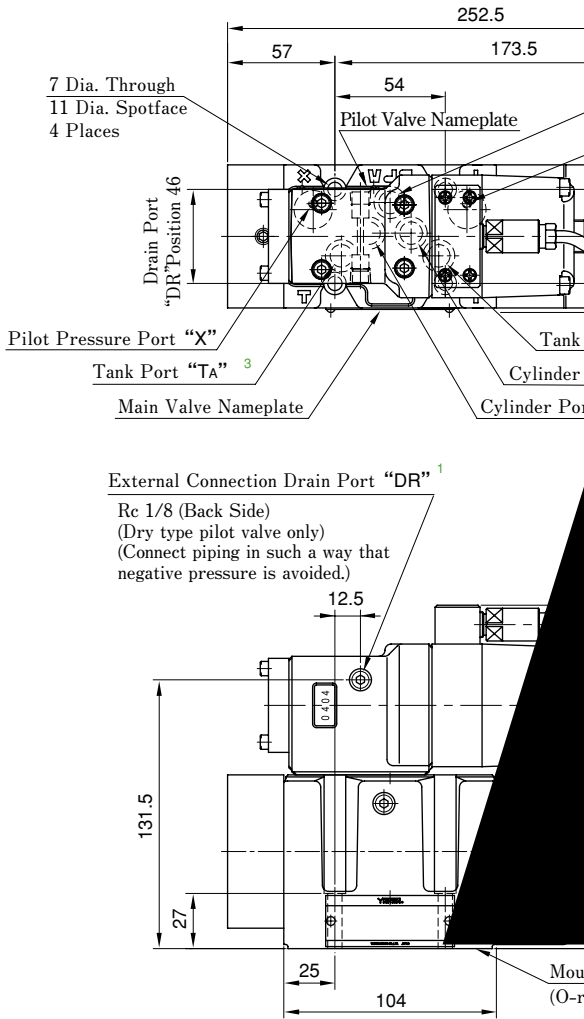

Mounting Surface: Conforming to ISO 4401-05-05-0-94

Model Number	C	Remarks
--------------	---	---------

... Sensor
 ... Applicable: Outside Dia. 8 - 10 mm
 ... 6 + PE/11 + PE Electrical Plug
 ... EN175201 Part 804

Color	Indicator Lamp
Green	Power Supply
Red	Pilot Valve Deviation Alarm
Yellow	Main Valve Deviation Alarm

- ★1. The external connection drain port "DR" on the front side is usually plugged. To use the port on the front side, remove the hexagon socket head plug (5 Hex.) and plug the port on the back side.
- ★2. To adjust the null, remove the protective screw and turn the null trimmer. After adjustment, be sure to attach the protective screw.
- ★3. There are two tank ports "TA" and "TB"; however, "TA" may be used alone.

LSVHG-03EH-60/100/160-S * - * EA/EB (With Fail-safe Solenoid Operated Valve)

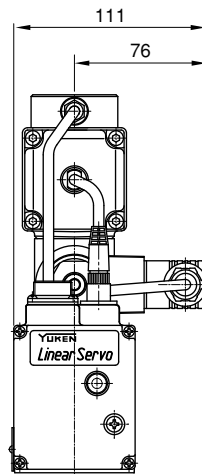
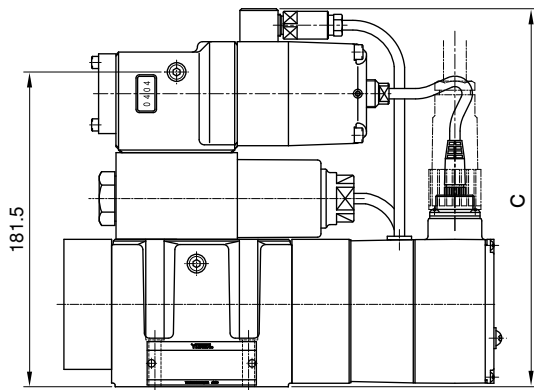

[Dimensions of Mounting Surface]
 The dimensions of the mounting surface are the same as those of the models LSVHG-03EH (page 37).

Detailed Graphic Symbol

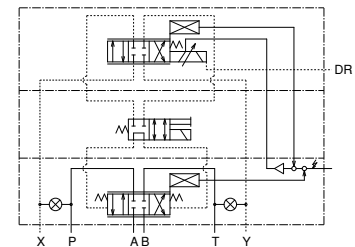

⊗ : Plugs for selecting the pilot and drain types

● O-rings for the Ports

Port	O-ring Size	Qty.
P, A, B, T	AS568-014 (NBR, Hs90)	5
X, Y	AS568-016 (NBR, Hs90)	2

O-rings made of fluorinated rubber are required to use phosphate ester type fluids.

Model Number	C	Remarks
LSVHG-03EH- *-S*-E *	218	Pilot Valve: Dry Type
LSVHG-03EH- *-S*-WE *	227	Pilot Valve: Wet Type

● For other dimensions, see the figures above (the models without a fail-safe solenoid operated valve).

LSVHG-04EH-100/200/280/450-S *

Model Number	C	Remarks
LSVHG-04EH- *-S*	194	Pilot Valve: Dry Type
LSVHG-04EH- *-S*-W	203	Pilot Valve: Wet Type

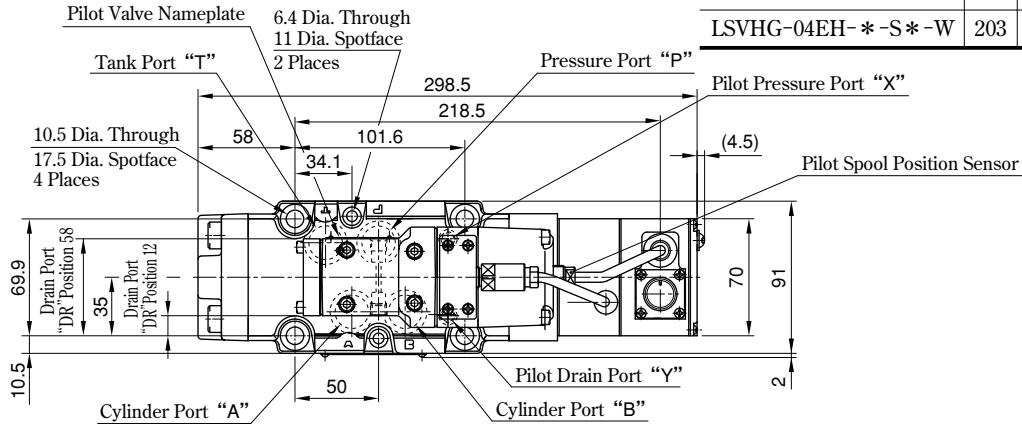

External Connection Drain Port "DR" ^{★1}

Rc 1/8 (Back Side)
(Dry type pilot valve only.)
(Connect piping in such a way that negative pressure is avoided.)

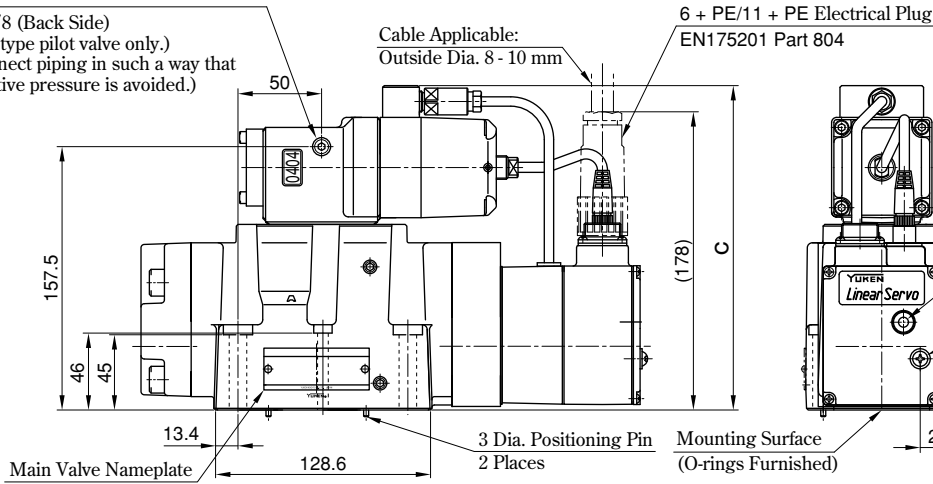

Color	Indicator Lamp
Green	Power Supply
Red	Pilot Valve Deviation Alarm
Yellow	Main Valve Deviation Alarm

Indicator Lamp
Protective Screw for Null Adjuster ^{★2}
M5 (+) Thd.

- ^{★1} The external connection drain port "DR" on the front side is usually plugged. To use the port on the front side, remove the hexagon socket head plug (5 Hex.) and plug the port on the back side.
- ^{★2} To adjust the null, remove the protective screw and turn the null trimmer. After adjustment, be sure to attach the protective screw.

LSVHG-04EH-100/200/280/450- * S- * EA/EB (With Fail-safe Solenoid Operated Valve)

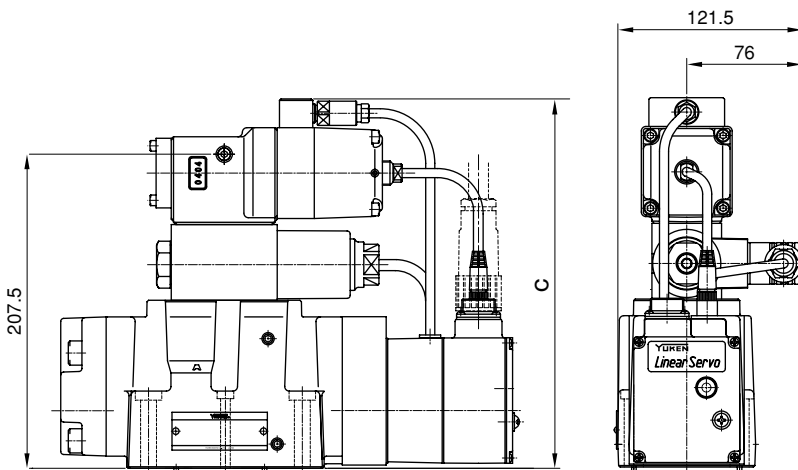

[Dimensions of Mounting Surface]

The dimensions of the mounting surface are the same as those of the models LSVHG-04 (page 11).

Detailed Graphic Symbol

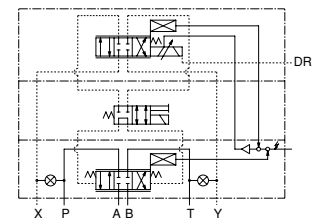

⊗: Plugs for selecting the pilot and drain types

● O-rings for the Ports

Port	O-ring Size	Qty.
P, A, B, T	JIS B2401-1B-P22	4
X, Y	AS568-012 (NBR, Hs90)	2

O-rings made of fluorinated rubber are required to use phosphate ester type fluids.

Model Number	C	Remarks
LSVHG-04EH- *-S*-E*	244	Pilot Valve: Dry Type
LSVHG-04EH- *-S*-WE*	253	Pilot Valve: Wet Type

● For other dimensions, see the figures above (the models without a fail-safe solenoid operated valve).

LSVHG-06EH-500/900-S *

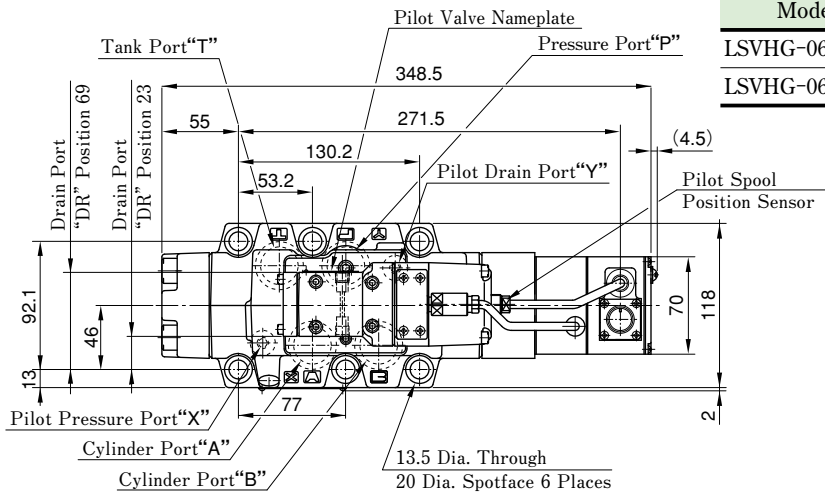

Model Number	C	Remarks
LSVHG-06EH- *-S*	220	Pilot Valve: Dry Type
LSVHG-06EH- *-S*-W	229	Pilot Valve: Wet Type

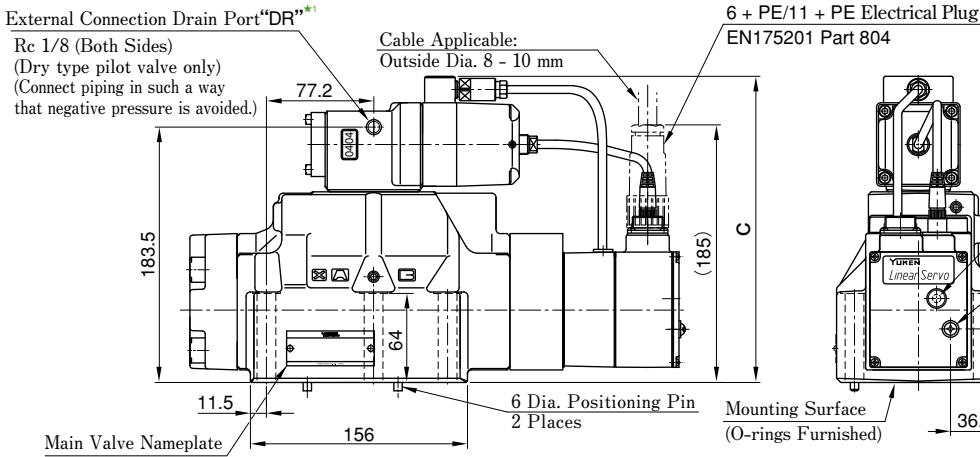

Color	Indicator Lamp
Green	Power Supply
Red	Pilot Valve Deviation Alarm
Yellow	Main Valve Deviation Alarm

- ★1. The external connection drain port "DR" on the back side is usually plugged. To use the port on the back side, remove the hexagon socket head plug (5 Hex.) and plug the port on the front side.
- ★2. To adjust the null, remove the protective screw and turn the null trimmer. After adjustment, be sure to attach the protective screw.

LSVHG-06EH-500/900- * S- * EA/EB (With Fail-safe Solenoid Operated Valve)

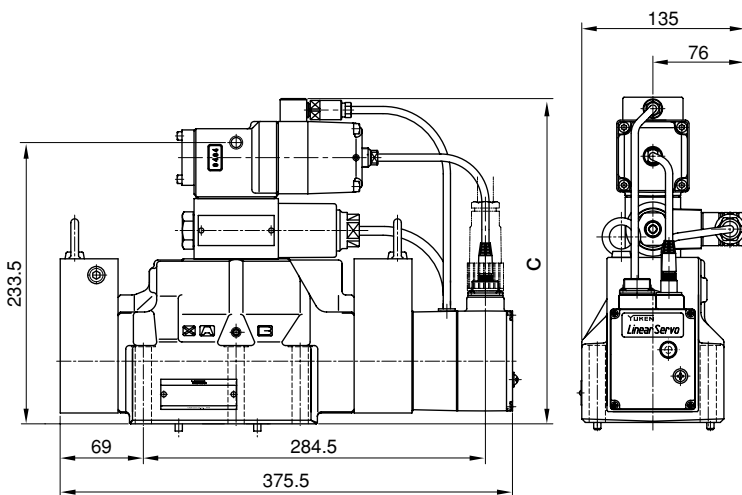

Detailed Graphic Symbol

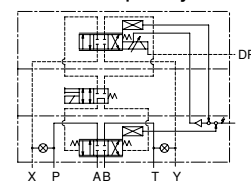

Model Number	C	Remarks
LSVHG-06EH- *-S*-E*	270	Pilot Valve: Dry Type
LSVHG-06EH- *-S*-WE*	279	Pilot Valve: Wet Type

● For other dimensions, see the figures above (the models without a fail-safe solenoid operated valve).

● O-rings for the Ports

Port	O-ring Size	Qty.
P, A, B, T	AS568-123 (NBR, Hs90)	4
X, Y	JIS B2401-1B-P14	2

O-rings made of fluorinated rubber are required to use phosphate ester type fluids.

[Dimensions of Mounting Surface]

The dimensions of the mounting surface are the same as those of the models LSVHG-06-900 (page 12).

Characteristics of LSVHG-03EH-60/100/160-S * (Fluid Viscosity: 30 mm²/s)

No-Load Flow Characteristics

Valve Pressure Difference: $\Delta P = 7 \text{ MPa}$ (Constant)
(4-Way Valve)

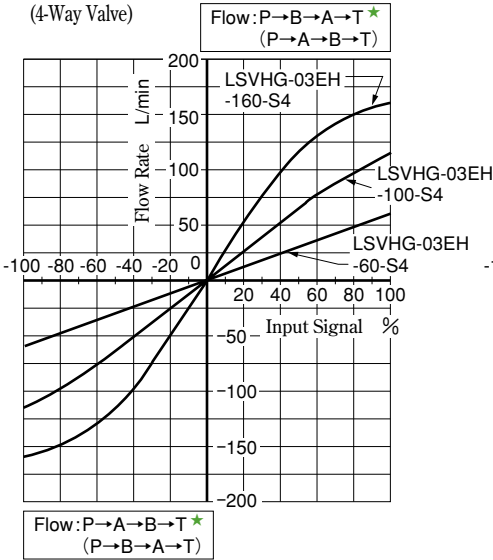

Valve Pressure Difference: $\Delta P = 3.5 \text{ MPa}$ (Constant)
(3-Way Valve)

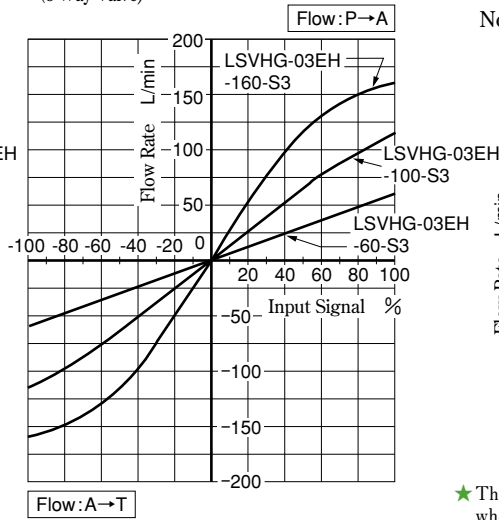

Load Flow Characteristics

<Conditions>

● Input Signal : 100 %

Note) Tolerance for Load Flow : $\pm 10 \%$

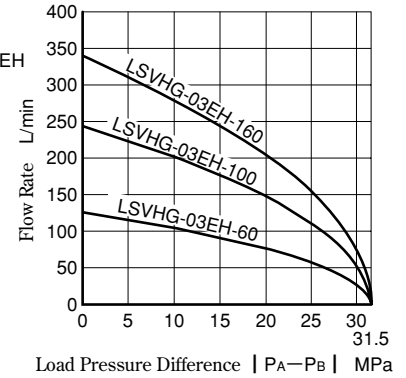

★ The flow outside of parentheses is achieved when the input signal type "A", "B", or "C" is selected. The flow in parentheses is achieved when "D", "E", or "F" is selected.

Step Response

<Conditions> ● Input Signal : 0 \leftrightarrow 100 % ● Supply/Pilot Pressure : 14 MPa

Pilot Valve: Dry Type

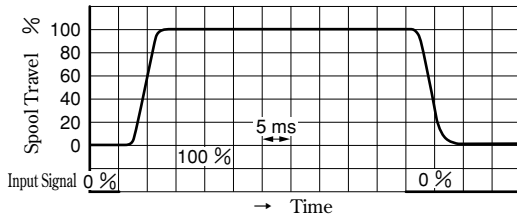

Pilot Valve: Wet Type

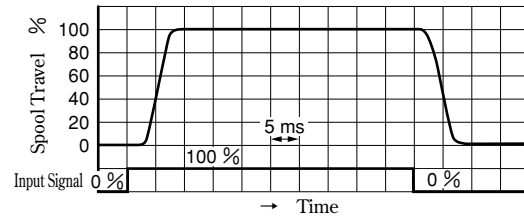

Frequency Response

<Conditions> ● Hydraulic Circuit: Port A/B Closed ● Supply/Pilot Pressure : 14 MPa

Pilot Valve: Dry Type

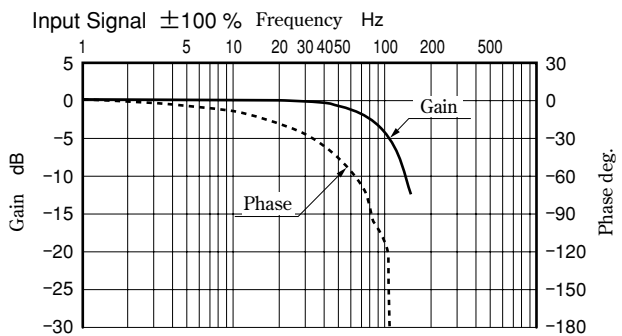
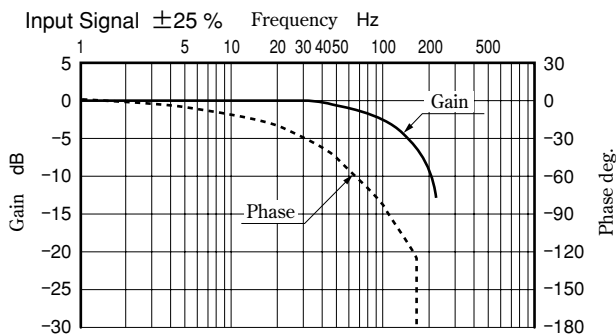

Pilot Valve: Wet Type

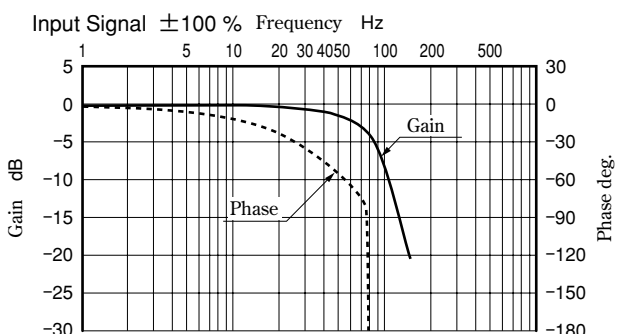
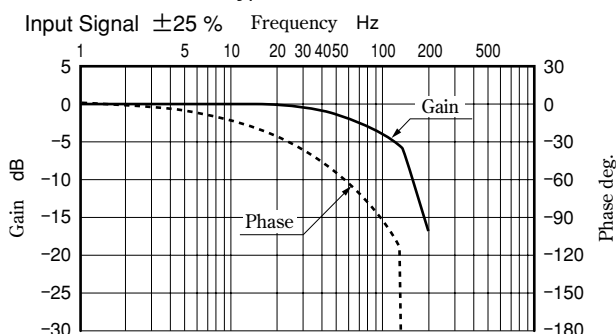

Characteristics of LSVHG-04EH-100/200/280/450-S* (Fluid Viscosity: 30 mm²/s)

No-Load Flow Characteristics

Valve Pressure Difference: $\Delta P = 7$ MPa (Constant)
(4-Way Valve)

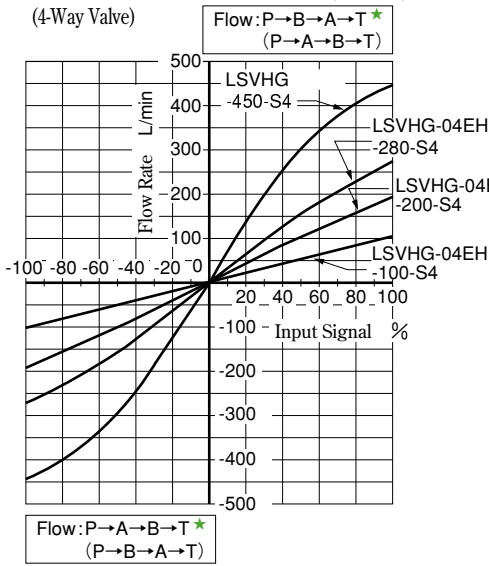

Valve Pressure Difference: $\Delta P = 3.5$ MPa (Constant)
(3-Way Valve)

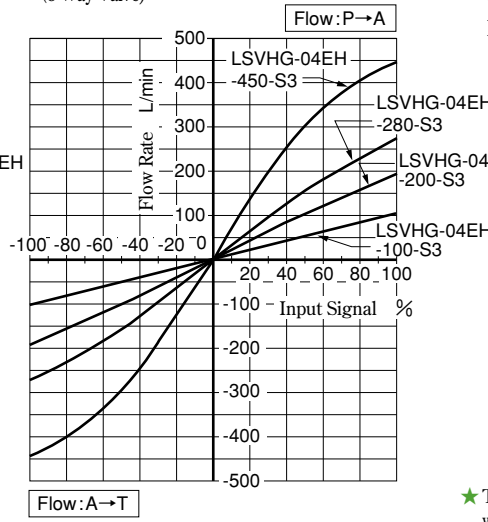

Load Flow Characteristics

<Conditions>

● Input Signal : 100 %

Note) Tolerance for Load Flow : ± 10 %

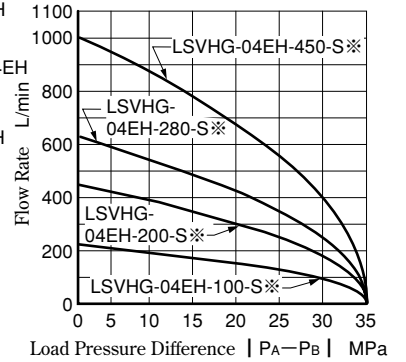

★ The flow outside of parentheses is achieved when the input signal type "A", "B", or "C" is selected. The flow in parentheses is achieved when "D", "E", or "F" is selected.

Step Response

<Conditions> ● Input Signal : 0 ⇔ 100 % ● Supply/Pilot Pressure : 14 MPa

● Pilot Valve: Dry Type

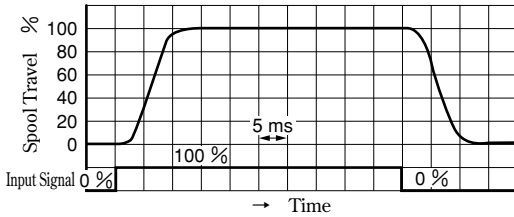

● Pilot Valve: Wet Type

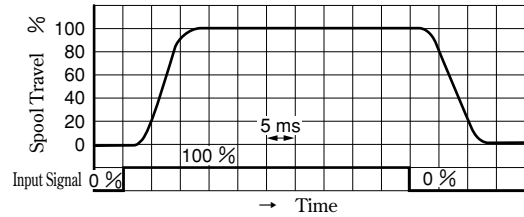

Frequency Response

<Conditions> ● Hydraulic Circuit: Port A/B Closed ● Supply/Pilot Pressure : 14 MPa

● Pilot Valve: Dry Type

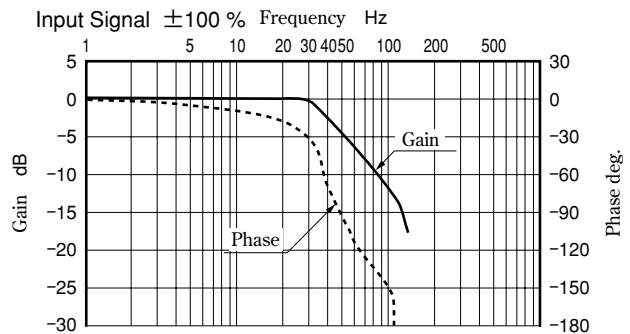
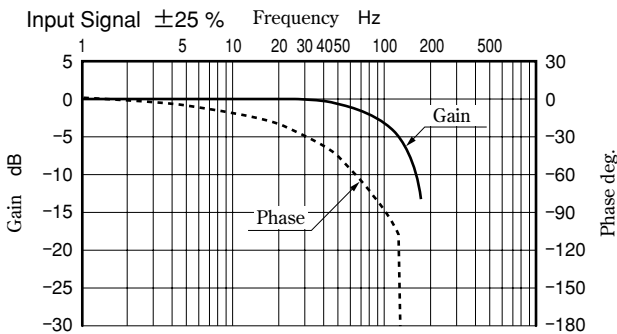

● Pilot Valve: Wet Type

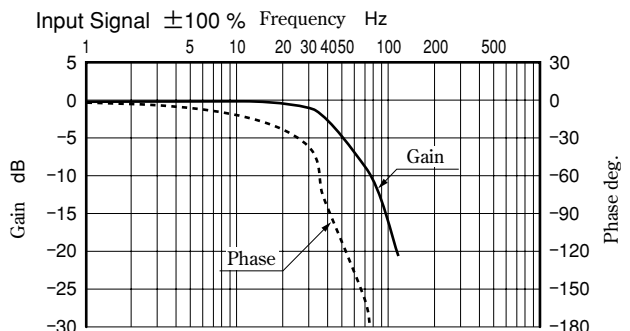
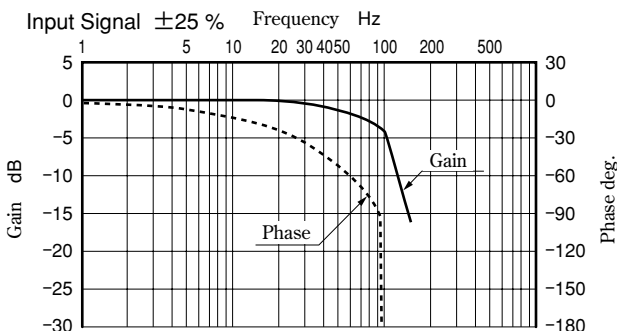

Characteristics of LSVHG-06EH-500/900-S * (Fluid Viscosity: 30 mm²/s)

No-Load Flow Characteristics

Valve Pressure Difference: $\Delta P = 7 \text{ MPa}$ (Constant)
(4-Way Valve)

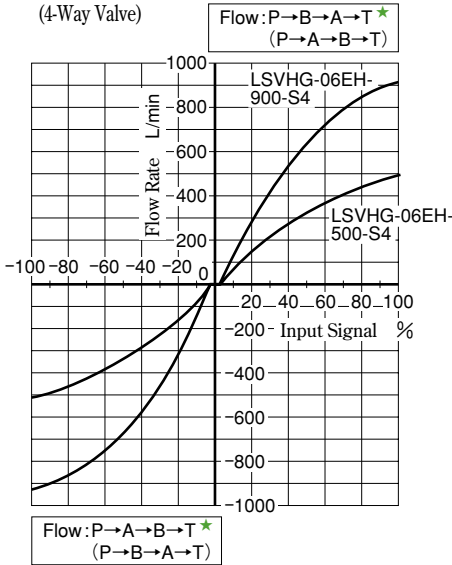

Valve Pressure Difference: $\Delta P = 3.5 \text{ MPa}$ (Constant)
(3-Way Valve)

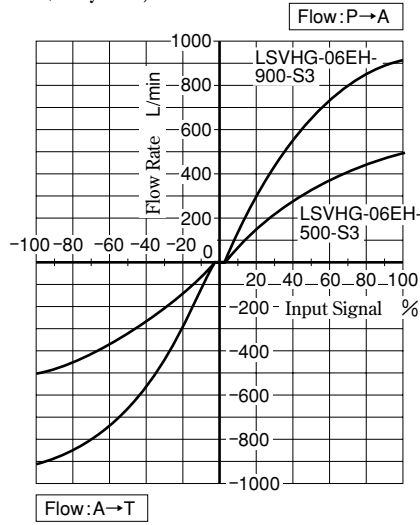

Load Flow Characteristics

<Conditions>

● Input Signal : 100 %

Note) Tolerance for Load Flow : $\pm 10 \%$

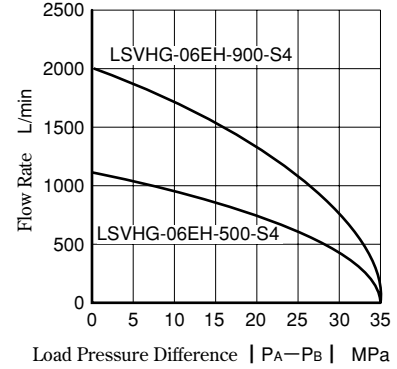

★ The flow outside of parentheses is achieved when the input signal type "A", "B", or "C" is selected. The flow in parentheses is achieved when "D", "E", or "F" is selected.

Step Response

<Conditions> ● Input Signal : 0 \leftrightarrow 100 % ● Supply/Pilot Pressure : 14 MPa

Pilot Valve: Dry Type

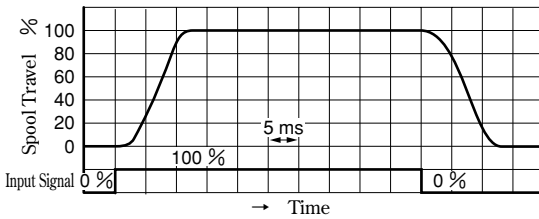

Pilot Valve: Wet Type

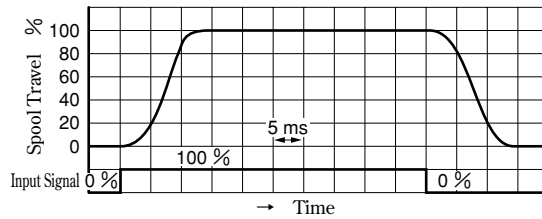

Frequency Response

<Conditions> ● Hydraulic Circuit: Port A/B Closed ● Supply/Pilot Pressure : 14 MPa

Pilot Valve: Dry Type

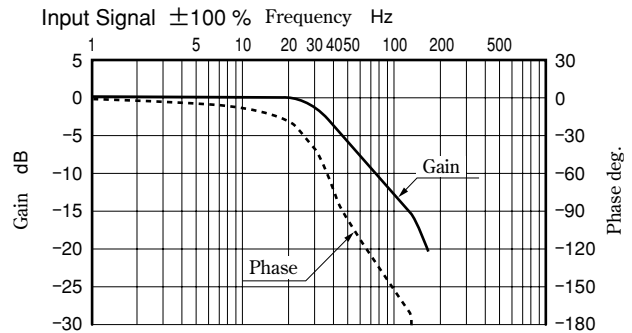
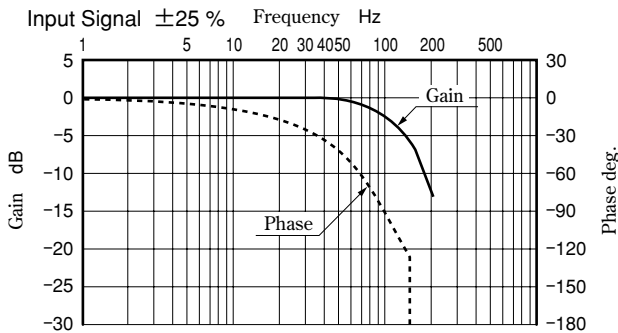

Pilot Valve: Wet Type

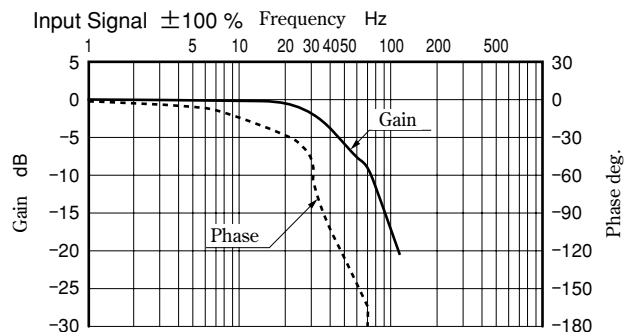
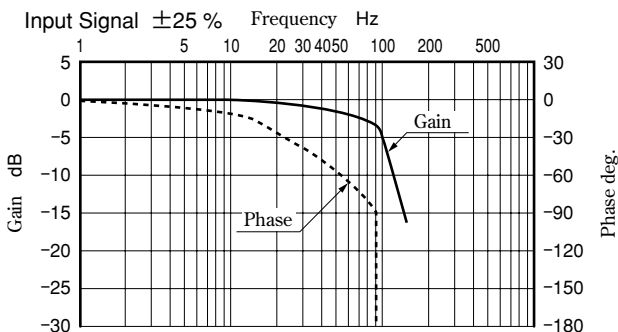

Effective Ranges of the Fail-safe Function for OBE (On-Board Electronics) Type Linear Servo Valves

- LSVHG-03EH-230/270-
- LSVHG-03EH-210-4J-
- LSVHG-03EH-60/100/160-S4-

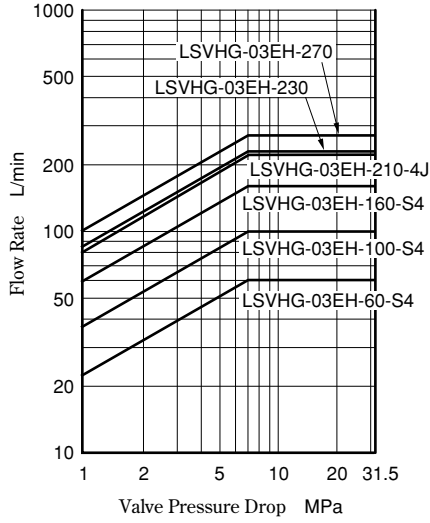

- LSVHG-03EH-60/100/160-S3-

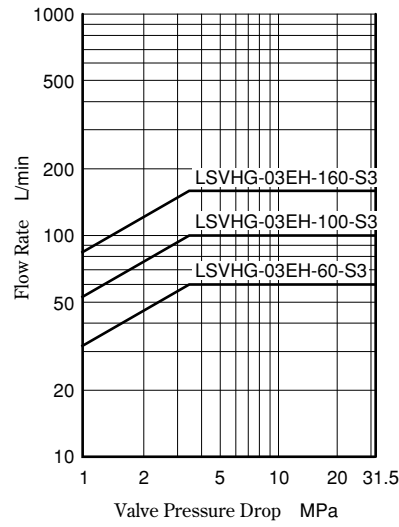

- LSVHG-04EH-750-
- LSVHG-04EH-580-4J-
- LSVHG-04EH-100/200/280/450-S4-

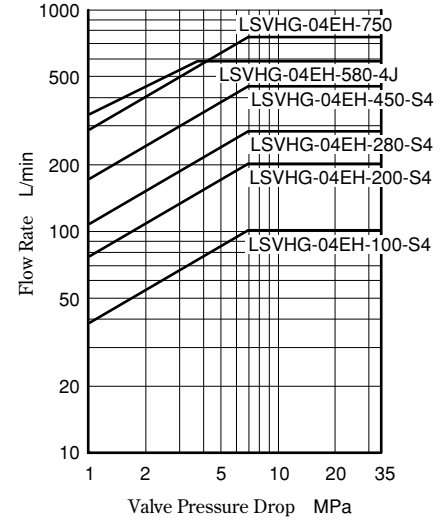

- LSVHG-04EH-100/200/280/450-S3-

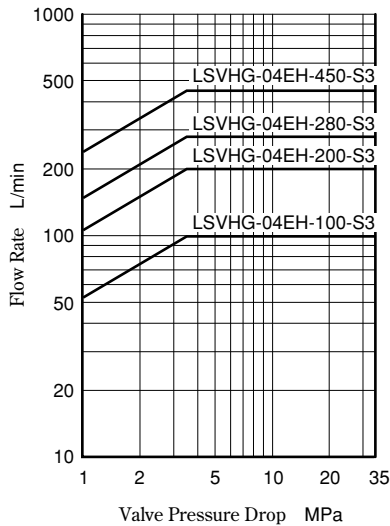

- LSVHG-06EH-900/1300
- LSVHG-06EH-820-4J-
- LSVHG-06EH-500/900-S4-

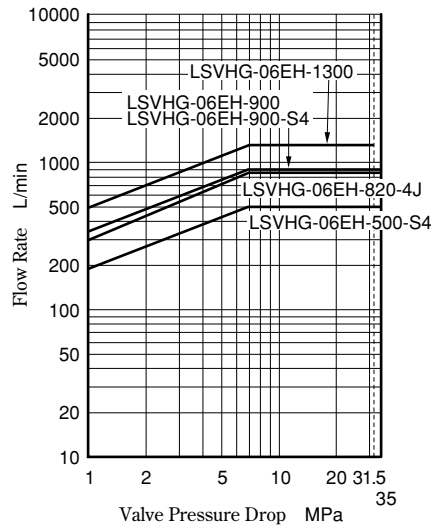

- LSVHG-06EH-500/900-S3-

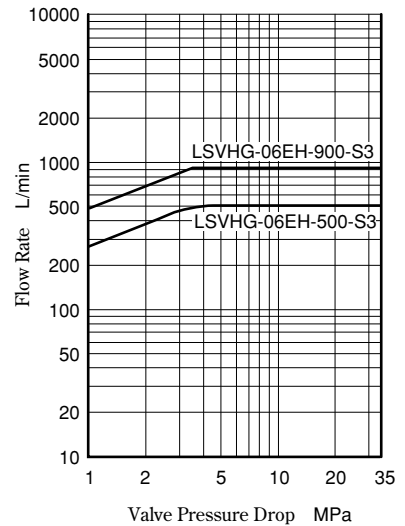

- LSVHG-10EH-3800-

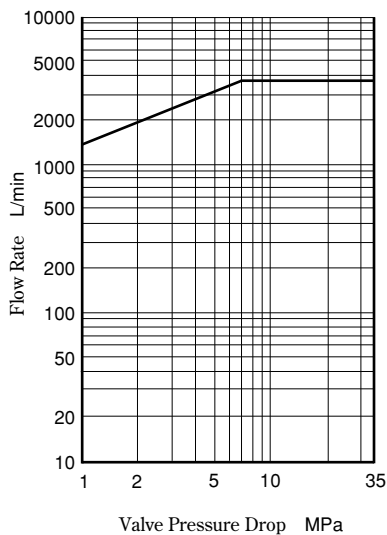

Memo

Memo

Linear Servo Valves Catalogue

June, 2014 Second Edition

Published

Yuken Kogyo Co., Ltd.

Sales Planning Section

Sales Planning Dept.

4-8, Shiba-Daimon 1 Chome,

Minato-ku, Tokyo 105-0012, Japan

TEL. +81-3-3432-2113

FAX. +81-3-3436-2344

Printer

See code number on back cover

Please address your inquiries regarding this
catalogue to the International Sales Department.

TEL. +81-467-77-3111

FAX. +81-467-77-3115



YUKEN KOGYO CO.,LTD.

International Sales Department (Sagami office):

4-4-34, Kamitsuchidana-Naka
Ayase, Kanagawa 252-1113, Japan

Telephone : +81-467-77-3111 E-mail : int.bd@yuken.co.jp
Facsimile : +81-467-77-3115 URL <http://www.yuken.co.jp>

